

VOIDDOM

Lighting

Lighting



At Vondom, we have always been known for offering innovative and unique designer outdoor lighting, planter, furniture and rugs. Since we began our trajectory in 2008 manufacturing designer objects with simple lines, our hallmark has been innovation. These new collections respond to an evolution marked by our search for greater sustainability, incorporating natural, 100% recyclable materials.

Designers

A-Cero	24
Estudi{H}ac	26
Eugeni Quitllet	22
Javier Mariscal	32
Ramón Esteve	06
Studio Vondom	38
Teresa Sapey	30

Designers	46
Dimensions	50
Technical Info	58

Collections

B	Blanca	36
	Bloom	22
	Bubbles	38
C	Chrismy	30
	Faz	16
F	Forest	14
G	Gatsby	12
J	Jut	40
M	Marquis	26
	Mora	32
P	Posidonia	06
S	Sabinas	34
T	The Factory	10
	The Second Light	42
U	Ulm	20
V	Vases	28
	Vela	18
W	Wing	24

Lighting / Iluminación



Posidonia
P. 06
Ramón Esteve
P. 52



Sabinas
P. 34
Javier Mariscal
P. 55



Ulm
P. 20
Ramón Esteve
P. 57



Jut
P. 40
Studio Vondom
P. 54

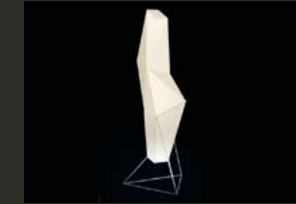

Faz
P. 16
Ramón Esteve
P. 53



The Second Light
P. 42
Studio Vondom
P. 56



Wing
P. 24
A-Cero
P. 57



Mora
P. 32
Javier Mariscal
P. 54



Blanca
P. 36
Javier Mariscal
P. 52



Marquis
P. 26
Estudi{H}ac
P. 55



Marquis
P. 26
Estudi{H}ac
P. 55



Gatsby
P. 12
Ramón Esteve
P. 54



Vela
P. 18
Ramón Esteve
P. 57



Vela
P. 18
Ramón Esteve
P. 57



Forest
P. 14
Ramón Esteve
P. 54



Chrismy
P. 30
Teresa Sapey
P. 53



Vases
P. 28
Estudi{H}ac
P. 56



Vases
P. 28
Estudi{H}ac
P. 56



The Factory
P. 10
Ramón Esteve
P. 55



Bloom
P. 22
Eugeni Quitllet
P. 52



Bubbles
P. 38
Studio Vondom
P. 52

Posidonia



by Ramón Esteve

6

Vondom's Posidonia lamps are distinguished by their exceptional construction in aluminium profiles, 100% recyclable. This collection embodies a perfect fusion of design and functionality, while paying homage to its Mediterranean roots.



P. 6
Posidonia lamps
(Crema + RGBW)

P. 7
Posidonia lamps
(Cacao + RGBW)

P. 8
Posidonia lamps
(Crema + RGBW)

P. 9
Posidonia lamps
(Crema + RGBW)



The Factory



10

by Ramón Esteve

P. 10
The Factory lamp S,
lamp M and lamp L
(Cacao + RGBW)

P.11
The Factory lamp S,
lamp M and lamp L
(Cacao + RGBW)

The Factory lamp is inspired by New York iron architecture and captures the essence of iconic New York districts such as Tribeca and Soho, adding authenticity to any outdoor space. Available in three sizes, it combines an aluminium frame and deployé mesh for durability and an industrial appeal.



Gatsby

reddot winner 2020



12

by Ramón Esteve

The Gatsby lamp captures the essence of the Roaring Twenties and Art Deco. Inspired by Francis Scott Fitzgerald's novel "The Great Gatsby", it evokes the luxury and extravagance of the era. With suggestive lighting and surfaces imitating etched glass, this lamp offers autonomy, light regulation and colour options. Its symmetrical patterns create a unique atmosphere, fusing simple beauty with intricate design. Gatsby is a technical and aesthetic masterpiece that brings an extraordinary elegance to any space.

P. 13
Gatsby Prism
table lamp
(Amber and clear)

P. 12
Gatsby Cylinder
table lamp
(Fume)

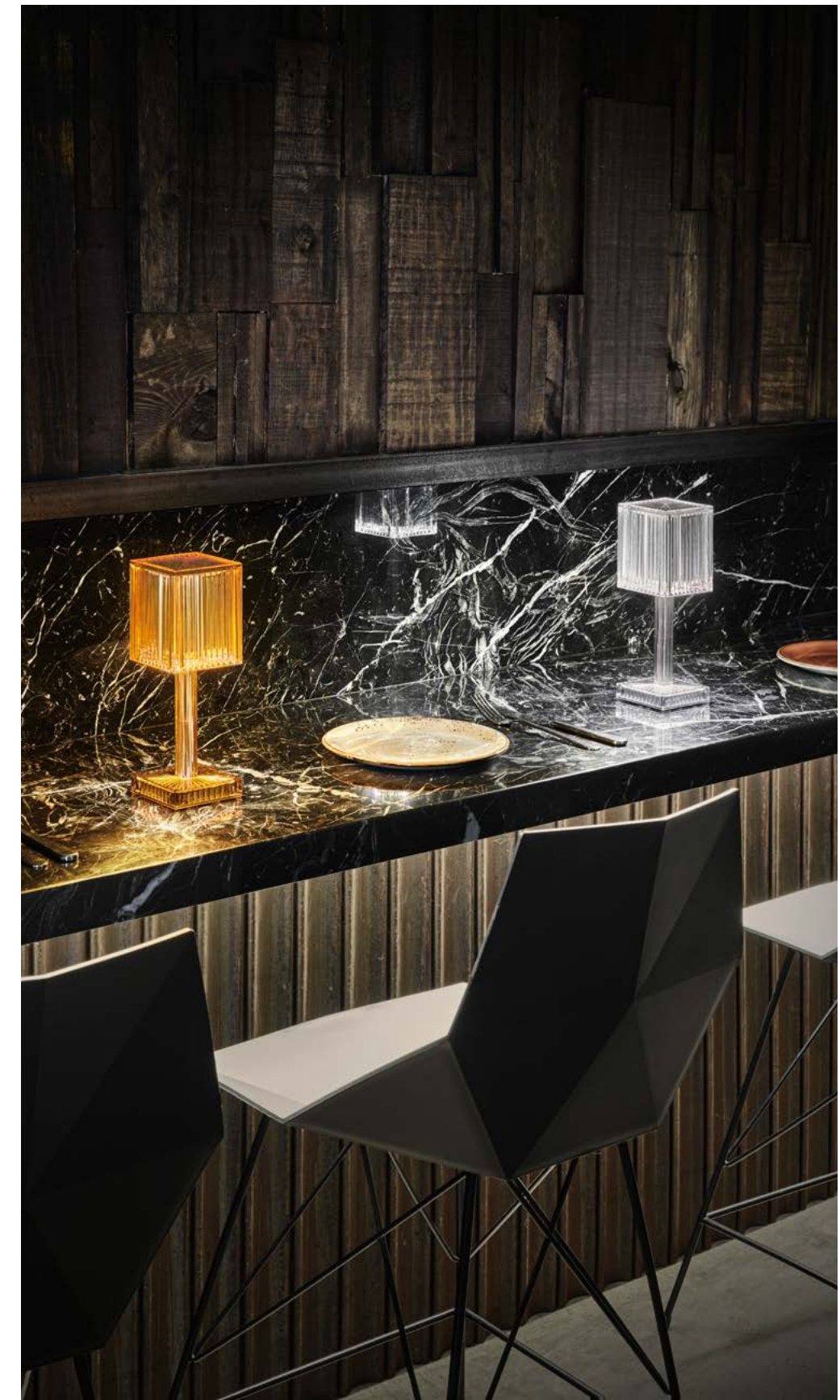

Forest



14

by Ramón Esteve

A backlit piece inspired by the geometric abstraction of a Christmas fir tree. With clean and elegant lines, Forest is a sophisticated and timeless ornament, which thanks to its RGB LED system, offers an enveloping atmosphere. Suitable for indoor and outdoor use, Forest is a magical tree that invites you to experience the beauty of nature in an “illuminated forest” during Christmas with your loved ones.



P. 14
Forest 2m
(Ice + RGBW)

P. 15
Forest 2m,
1,5m and 1m
(Ice + RGBW)

Faz

16

by Ramón Esteve

P. 16
Faz lamp
(Ice + RGBW)

P. 17
Faz lamp
(Ice + RGBW)

Inspired by natural mineral forms, it creates sculptural visual effects through folds on its faces, evoking crystallised quartz. Made of technical polyethylene resins and metal support, its LED lighting is waterproof (IP65), allowing it to be used in extreme exteriors. A piece that combines nature and technology in an attractive design.



Vela



18

by Ramón Esteve

P. 18
Vela lamps
(Ice + RGBW)

P. 19
Vela lamps
(Ice + RGBW)

The Vela lamp is an example of modern, minimalist design with sleek, geometric lines. Perfect for public spaces and gardens, its prismatic and modular design allows for exceptional versatility in any environment. Its volumes appear to float and take on a light appearance when illuminated. Made from double-walled polyethylene resin, it is 100% recyclable and suitable for indoor and outdoor use. Vela is available in various finishes to suit different styles.



Ulm



20

by Ramón Esteve

The Ulm lamp stands out for its conical shape, where a transparent envelope contains a translucent conical silhouette that houses the luminaire. The combination of colour, light and transparency is used in a subtle way. This piece uses innovative plastic materials, such as polyethylene, which make it resistant for outdoor use. Despite its large size, Ulm does not dominate the outdoor space thanks to its lightness and transparency, which makes it elegant and presential.

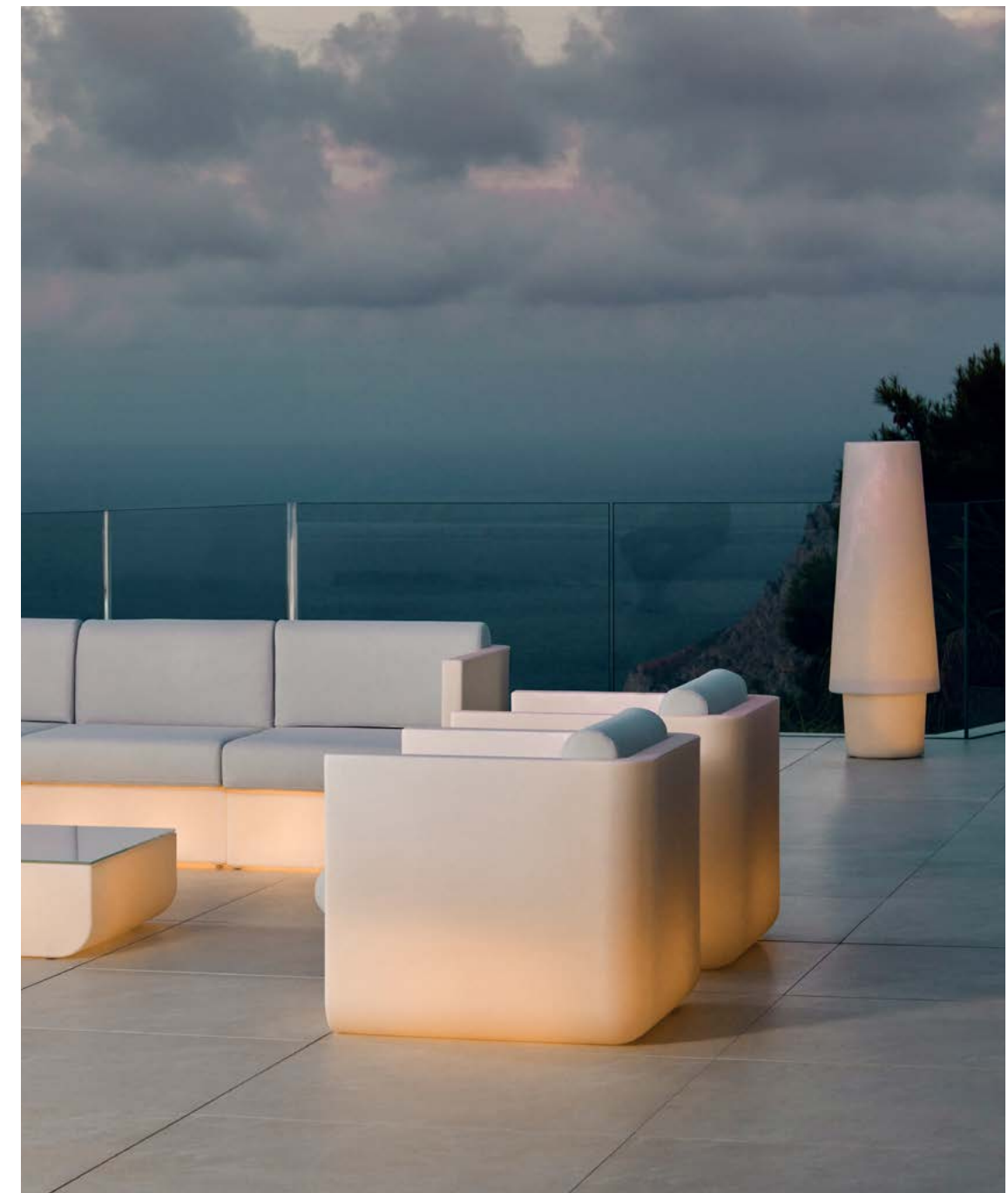

P. 20
Ulm lamps
(Ice + RGBW)

P. 21
Ulm lamps
(Ice + RGBW)

Bloom



22

by Eugeni Quitllet

P. 22
Bloom lamp
(Ice + RGBW)

P. 23
Bloom lamp
(Ice + RGBW)

Eugeni Quitllet creates the piece BLOOM in metaphorically evoking flowering. Ideal for public spaces due to its beautiful form and atmosphere, it establishes a connection between the luminaire and its sculptural ringed shape, generating play of light with LED technology. Inspired by transformation, BLOOM becomes an ode to nature, a night light that becomes a flowerpot by day, a marine mirage that blooms at dawn.



Wing



24

by A-Cero

P.24
Wing Lamps
(Ice + RGBW)

P.25
Wing Lamps
(Ice + RGBW)

The Wing lamp is the result of a dynamic interplay between straight lines and curves that fold in a unique way. These bold, organic shapes reflect A-cero's architectural avant-garde, moving away from octagonal rigidity. These design pieces stand out for their visual strength and sculptural expression. Manufactured with resistant materials, making them suitable for both indoor and outdoor spaces



Marquis



26

by Estudi{H}ac - JM Ferrero

P. 26
Marquis
table lamp
(Clear)

P. 27
Marquis
table lamp
(Clear)

The Marquis table lamp, designed by estudi{H}ac for Vondom, is based on the geometry of folds inspired by folded paper moulds, creating a texture of shiny polycarbonate triangles. The light that passes through these shapes creates a surprising play of shadows and light, projecting textures that evoke pleated fabrics on the surfaces. Marquis is a piece that plays with the interplay of light and geometry to create a captivating visual effect.



Vases



28

by Estudi{H}ac - JM Ferrero

P. 28
Vases lamp
(Ice + RGBW
ø30 and ø40)

P. 29
Vases lamp
(Ice + RGBW. 70 cm,
180 cm and 220 cm)

The Vases lamps stand out for their unusual scale and subtle play of diamond-shaped textures. Designed for large spaces, these pieces become points of differentiation that create different atmospheres. Thanks to LED technology, it is possible to change the colour and adjust the intensity with a remote control. The family includes floor models of various heights, pendant and table lamps, offering versatility in lighting.



Chrismy



The Chrismy collection is inspired by the elegance of natural forms that gracefully ascend towards their peak in a flowing silhouette. Its interior lighting creates enveloping atmospheres, suitable for a variety of environments. This renewed classic perfectly combines timeless modernity and is versatile in its adaptability. The logical continuity of its design achieves pure visual magic, enveloping with its beauty and sophistication.

P. 80
Chrismy tree
(Ice + RGBW, 1,5m)

P. 81
Chrismy tree
(Ice + RGBW, 0,5m,
1m, 1,5m y 2m)



Mora



32

by Javier Mariscal

P. 32
Mora lamps
(Ice + RGBW
58cm and
103cm)

P. 33
Mora lamps
(Ice + RGBW
58cm and
103cm)

The Mora lighting collection draws inspiration from traditional punched metal lamps. Notable for its design, functionality, and ecological considerations, this collection features compact, geometric shapes with textured bas-relief patterns created by Javier Mariscal. This blend of pure geometry and texture provides a balanced and characterful light. Functional details, like a colorful handle for portability or hanging, make it versatile for outdoor use. Available in two sizes, the Mora lighting it's a unique and exclusive lighting.



Sabinas



34

by Ramón Esteve

P. 34
Sabinas lamps
(Ice + RGBW
88cm and 130cm)

P. 35
Sabinas lamps
(Ice + RGBW
88cm and 130cm)

Sabinas lamps explore organic and fluid shapes that defy straight lines and conventional geometry. Their curves evoke dunes and the soft lines of the female anatomy. Beyond its function, Sabinas establishes a special relationship of affection with the user. Mariscal's distinctive signature is reflected in every detail.



Blanca

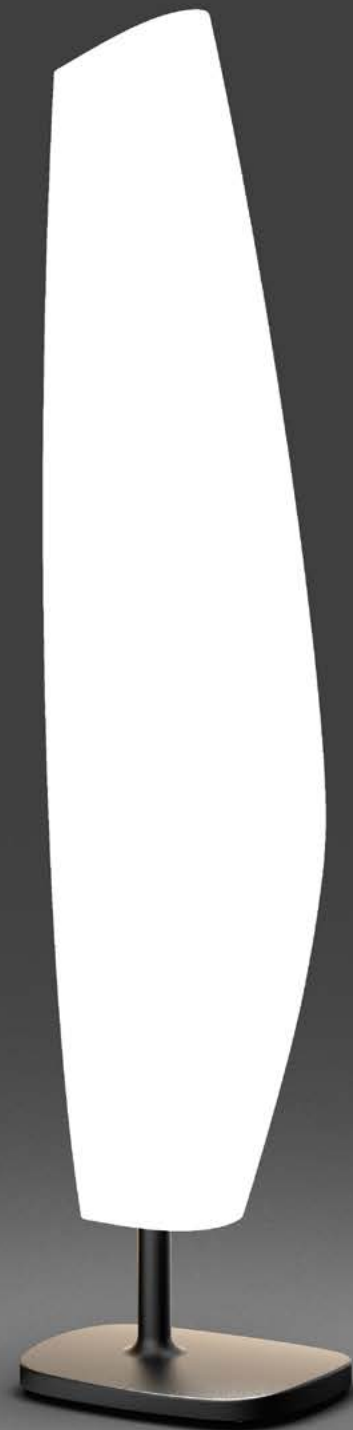

The Blanca lamp is an expression of boldness and creativity. Its organic, rounded design reflects Mariscal's distinctive graphic language and is perfectly suited to the rotational moulding technique in polyethylene resin. With a lacquered metal base and rigorous quality testing, Blanca is ideal for both contract and domestic use indoors or outdoors, withstanding extreme weather conditions. Its extroverted personality and exceptional quality set it apart.



P. 36
Blanca lamp
(Ice + RGBW)

P. 37
Blanca lamp
(Ice + RGBW)

Bubbles



38

by Studio Vondom

The Bubbles lamps by Studio Vondom are spherical and versatile, designed for floor or suspension. Their minimalist design adapts to any environment. Made of recyclable polyethylene resin, they are ideal for both indoors and outdoors.

P. 38
Bubbles
(Ice + RGBW
Ø60)

P. 39
Bubbles
(Ice + RGBW
Ø30, Ø40, Ø50
and Ø60)



Jut



40

by Studio Vondom

The Jut lamp by Studio Vondom is a minimalist piece of polyethylene resin, with LED lighting, perfect for modern exteriors and interiors. Its versatile design creates enveloping atmospheres in a variety of environments.



P. 40
Jut Chill lamp
(Ice + RGBW)

P. 41
Jut Chill lamp
(Ice + RGBW)

The Second Light



42

by Studio Vondom

P. 42
The Second
Light lamp
(Ice + RGBW)

P. 43
The Second
Light lamp
(Ice + RGBW)

The Second Light by Studio Vondom is a versatile set of three lighting pieces suitable for indoor and outdoor use. Made of polyethylene resin and stainless steel, they combine freshness and design. Available with energy-saving or RGB LED lamps, these lights transform any space into a harmonious and personal environment, adapting to a variety of lighting needs.

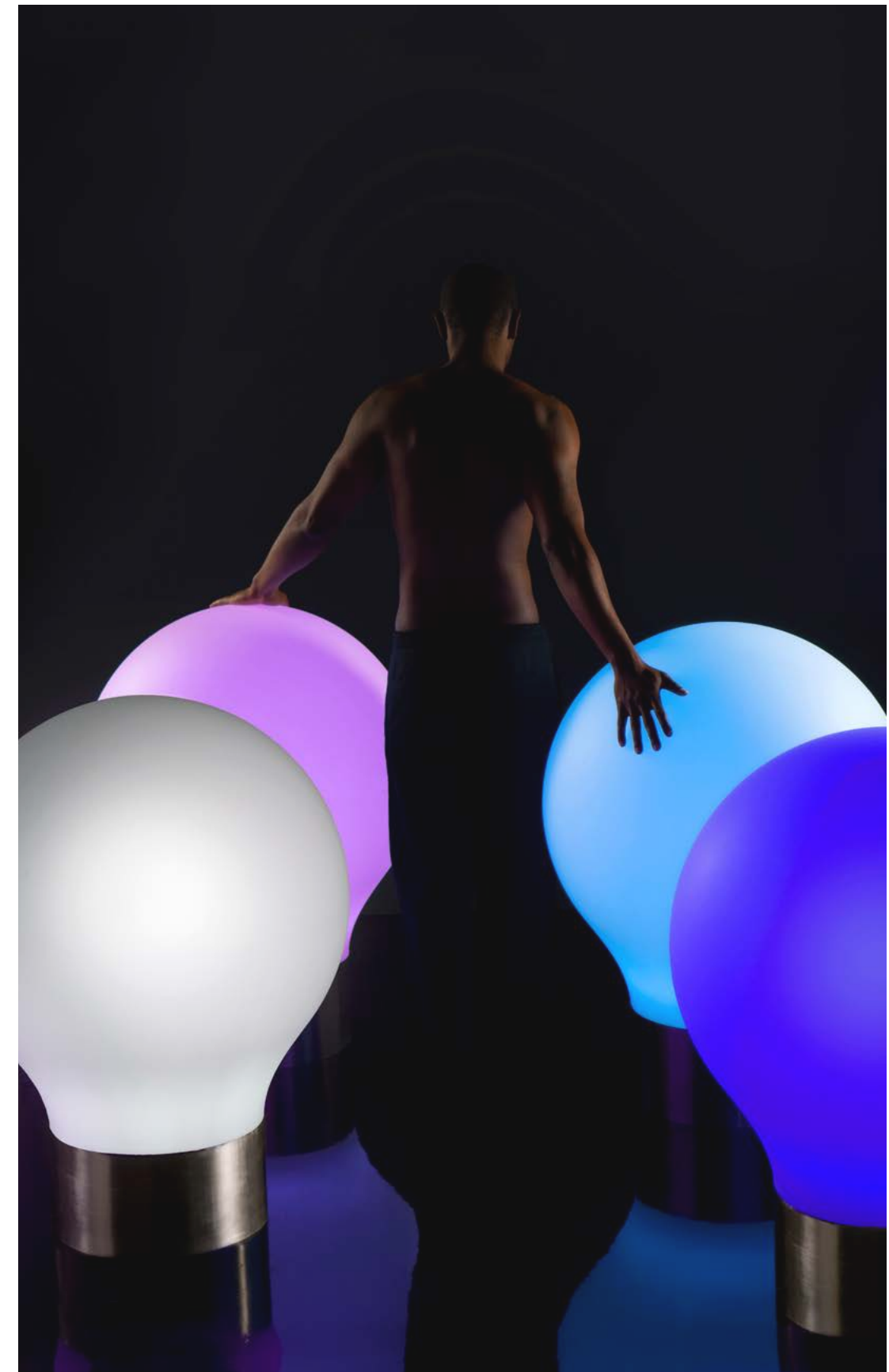

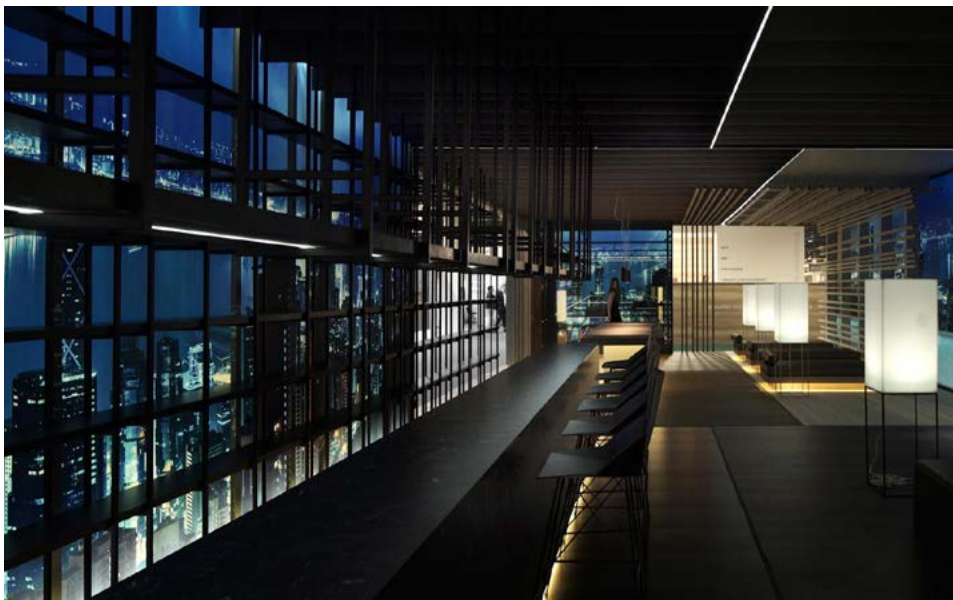

Designers



We travel the world until we find the best ambassadors of the Vondom spirit: Fabio Novembre, Stefano Giovannoni, Eugeni Quitllet, Ora-ïto, Ross Lovegrove, Karim Rashid, Javier Mariscal... Renowned designers and architects from all over, it doesn't matter where. What counts is their passion for shapes, culture and the vanguard. They transform each piece of furniture into an exclusively "Vondom" mode of expression. Nothing is random, everything happens for a reason. Just as Ramón Esteve become our artistic director for a very good reason.

Ramón Esteve

Creative Director

Posidonia, Hamptons, The Factory, Tablet, Pixel, Gatsby, Kimono, Faz, Frame, Quartz, Ulm, Vineyard, Vela

Ramón Esteve Cambra is Architect and Designer, arising one facet as a consequence of the other. In 1991, he founded Ramón Esteve Estudio with the premise that architecture is a global discipline.

His training as an architect became a transversal vision where Architecture and Design form one single concept, almost inseparable, both generated under the same laws and the same design premises. Its aim is the development of complete environments through a mutual interaction between both disciplines, so design acts on architecture and vice versa and the importance and difficulty of both disciplines are equally acknowledged.

Eugeni Quitllet

Ibiza, Love, Bum-Bum, Africa, Brooklyn, Wall Street, Mari-sol, Pedrera, Bloom, Manta

The Catalan designer Eugeni Quitllet was born on 17th April 1972 in Ibiza. He graduated from 'La Llotja' art school in Barcelona. Through his creative vocabulary he exceeds simple relationships between function and style unveiling innovative objects.

Between drawing, sculpture and contemporary archaeology, Quitllet literally reveals silhouettes hidden in the material, extremely visual skeletal objects elegantly master fullness and emptiness often with a touch of humour: the Masters chair combines the 3 contours of legendary seats by Eames, Saarinen and Jacobsen, the K Ray lamp is an organic UFO, a network of veins hollowed out of the material which results in an object suspended in a frame, his signature method prevalent naturally in several of the designer's projects: the Shine vases, the Light Air lamp, the O'Clock lamp, without forgetting the O Ring watch, a hole in time in the true sense, best seller of the brand Fossil modernising watchmaking codes.

Eugeni Quitllet is a design world freak capable of devouring the whole of our environment in his own way to serve it up to us transformed.

A-cero

Wing, Rest, Alma

Joaquín Torres (*1969) – Rafael Llamazares (*1970), Spain. A-cero Joaquín Torres architects company established in 1996 whose activity focuses on complete development of architectural projects.

The human team, led by Joaquín Torres and his partner Rafael Llamazares, has been growing throughout the past year and sums up to more than 60 professionals spread out through different offices Spain, UAE Dubai, Dominican Republic, currently working on projects of different magnitude. "Our working method is based on a detailed analysis of the clients needs and the projects programme: we imagine, project and persuade. "The key to our success is that we stick to the initial idea throughout the whole process.

Estudi{H}ac - JM Ferrero

Vases, Marquis

In 2003, José Manuel Ferrero founded estudi{H}ac to give life to all the ideas that appeared unceasingly in his head and in just 16 years he has turned his design workshop into a national and international reference. The passion he puts into his work is evident from the very beginning. Discreet, cultured, elegant and immensely creative, for Ferrero design is a way of life that keeps the mind fully active in terms of creativity.

We could say that the British term "bespoke" is the dogma that governs each of the Valencian businessman's designs, as he creates pieces and elements tailored to each project.

Javier Mariscal

Sabinas, Noma, Blanca, Mora

Javier Mariscal is, First and foremost, an image creator who develops his work using all kinds of supports and disciplines. Furniture design, painting, sculpture, illustrations, interior design, graphic design, landscaping, gardening and so on are all the object of his professional, vital activity.

He has collaborated with companies such as Memphis, Akaba, Bidasoa, BD Ediciones de Diseño, Moroso, Nani Marquina, Vorwerk, Equipaje, Alessi, Sangetsu, Magis, Cosmic, Amat3, Santa&Cole, Lali que and Phaidon. Mariscal expresses himself using a personal language that is complex in its intention and simple in its statements, innocent yet provocative, that he uses to innovate, risk and communicate. He enjoys provoking the eyes that look at his works and creating complicity with them.

Teresa Sapey

Adan, Chrismy, Chemistubes

Studio Teresa Sapey is an architecture and design studio based in Madrid since it was founded in 1990. The team's guiding force streams from curiosity and energy. In fact, the range of fields approached by this practice is extremely broad: It varies from spaces to displays via furniture, graphics and editorial works. Projects not only stem from feelings, but they are also capable of transmitting these same emotions to their clients and customers. "By working with spaces my aim is to be touching and therefore render emotions palpable: Three-dimensional, even four-dimensional. No matter the feelings is, as far as it is a feeling, I would go for it! I believe that architecture should interpret, build and transmit these inspiringly and usefully."

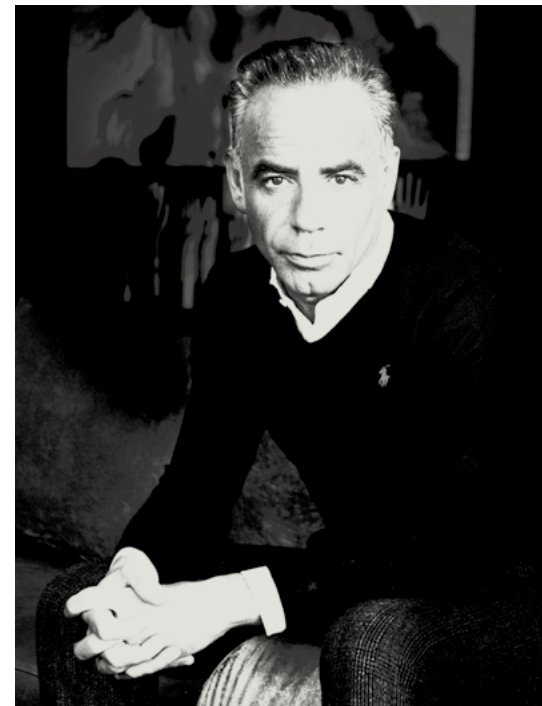

Dimensions



52	Blanca
52	Bloom
52	Bubbles
53	Chrismy
53	Faz
54	Forest
54	Gatsby
54	Jut Chill
54	Mora
55	Marquis
55	Sabinas
55	The Factory
56	The Second Light
56	Vases
57	Vela
57	Ulm
57	Wing

Lamps / Lámparas

Posidonia

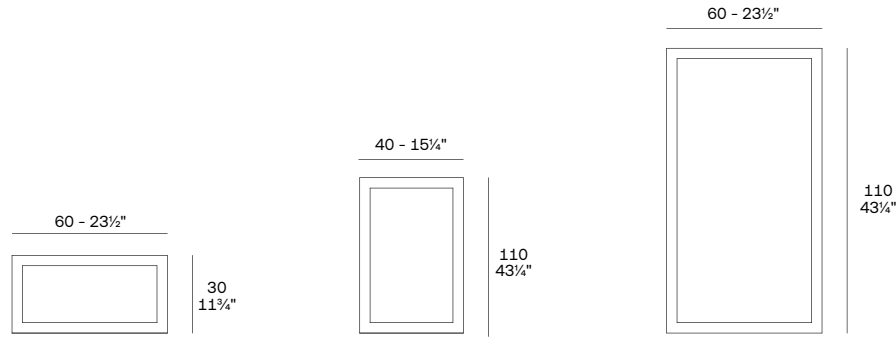

Posidonia. Lamp 60x30x12
Posidonia. Lámpara 60x30x12

Posidonia. Lamp 40x60x12
Posidonia. Lámpara 40x60x12

Posidonia. Lamp 60x110x12
Posidonia. Lámpara 60x110x12

	Metal Metal
Lamp 60x30x12 - Lámpara 60x30x12	54741
Lamp 40x60x12 - Lámpara 40x60x12	54743
Lamp 60x110x12 - Lámpara 60x110x12	54742

Blanca

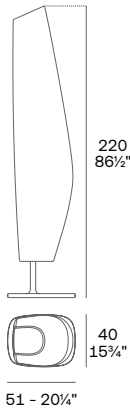

Blanca. Lamp Blanca. Lámpara	
White Led Cab. / Led Blanco Cab.	46050W
RGBW Led Cab. / Led RGBW Cab.	46050L
DMX Cab. / Led RGBW DMX Cab.	46050D
RGBW Led Batt. / Led RGBW Bat.	46050Y
DMX Batt. / DMX Bateria	46050DY

Bloom

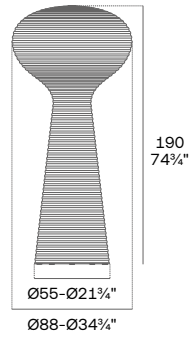

Bloom. Lamp Bloom. Lámpara	
White Led Cab. / Led Blanco Cab.	65018W
RGBW Led Cab. / Led RGBW Cab.	65018L
DMX Cab. / Led RGBW DMX Cab.	65018D
RGBW Led Batt. / Led RGBW Bat.	65018Y
DMX Batt. / DMX Bateria	65018DY

Bubbles

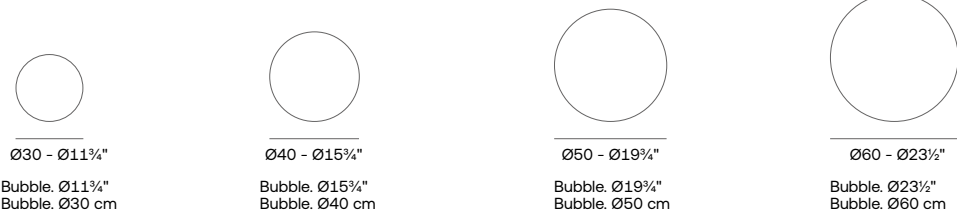

Bubble. Ø11 1/4"
Bubble. Ø30 cm

Bubble. Ø15 1/4"
Bubble. Ø40 cm

Bubble. Ø19 1/4"
Bubble. Ø50 cm

Bubble. Ø23 1/4"
Bubble. Ø60 cm

	White Led Cab. Led Blanco Cab.	RGBW Led Cab. Led RGBW Cab.	RGBW Led Batt. Led RGBW Bat.	DMX Cab. Led RGBW DMX Cab.	DMX Batt. DMX Bateria	Hanging Support Kit Kit Soporte Colgante
Ø11 1/4" - Ø30 cm	46003W	46003L	46003Y	46003D	46003DY	48000X
Ø15 1/4" - Ø40 cm	46004W	46004L	46004Y	46004D	46004DY	48000X
Ø19 1/4" - Ø50 cm	46005W	46005L	46005Y	46005D	46005DY	48000X
Ø23 1/4" - Ø60 cm	46006W	46006L	46006Y	46006D	46006DY	48000X

Chrimsky

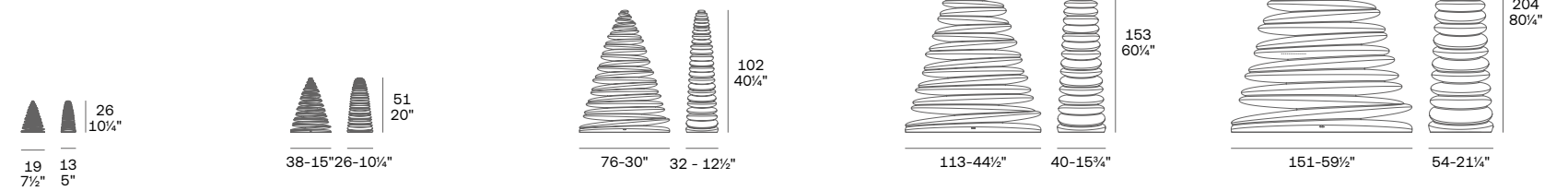

Chrimsky. Nano Tree 9 1/4"
Chrimsky. Nano Árbol 25cm

Chrimsky. Tree 19 3/4"
Chrimsky. Árbol 50cm

Chrimsky. Tree 39 1/4"
Chrimsky. Árbol 100cm

Chrimsky. Tree 59"
Chrimsky. Árbol 150cm

Chrimsky. Tree 78 3/4"
Chrimsky. Árbol 200cm

	White Led Cab. Led Blanco Cab.	RGBW Led Cab. Led RGBW Cab.	RGBW Led Batt. Led RGBW Bat.	DMX Cab. Led RGBW DMX Cab.	DMX Batt. DMX Bateria	Stainless Steel 2 Feet Set Kit 2 Pies Inox
Nano Tree 9 1/4" - Nano Árbol 25cm	49069W	-	49069Y	-	-	-
Tree 19 3/4" - Árbol 50cm	49070W	49070L	49070Y	49070D	49070DY	-
Tree 39 1/4" - Árbol 100cm	49073W	49073L	49073Y	49073D	49073DY	49073X
Tree 59" - Árbol 150cm	49071W	49071L	49071Y	49071D	49071DY	49071X
Tree 78 3/4" - Árbol 200cm	49072W	49072L	49072Y	49072D	49072DY	49072X

Faz

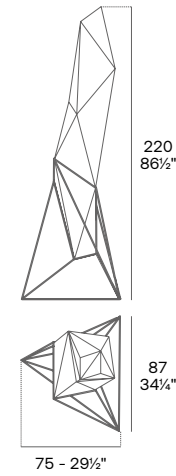

Faz. Lamp Faz. Lámpara	
White Led Cab. / Led Blanco Cab.	54018W
RGBW Led Cab. / Led RGBW Cab.	54018L
DMX Cab. / Led RGBW DMX Cab.	54018D
RGBW Led Batt. / Led RGBW Bat.	54018Y
DMX Batt. / DMX Bateria	54018DY

Forest

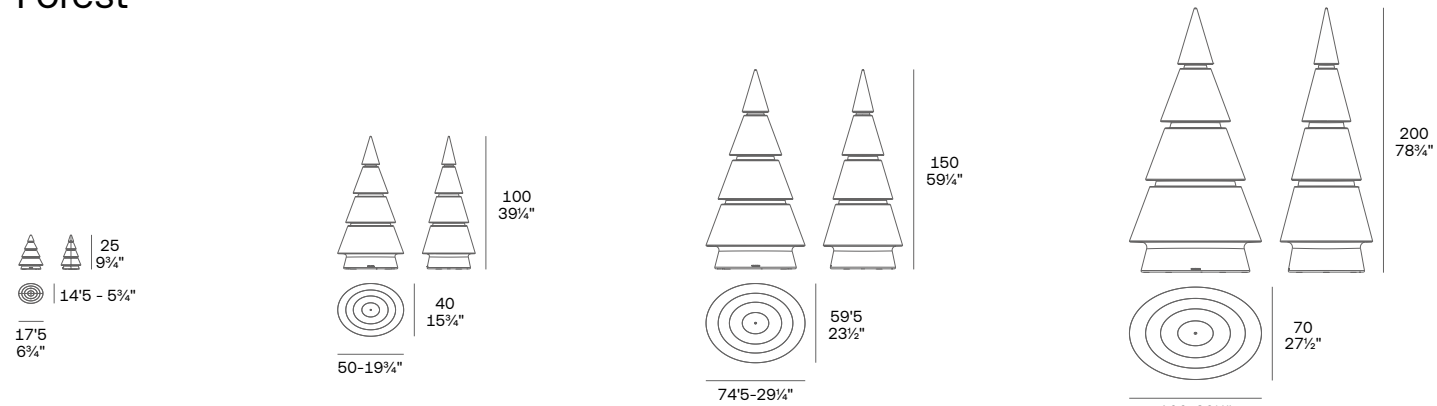

Forest. Nano Tree 9 1/4" Forest. Nano Árbol 25cm
 Forest. Tree 19 3/4" Forest. Árbol 100cm
 Forest. Tree 39 1/4" Forest. Árbol 150cm
 Forest. Tree 59" Forest. Árbol 150cm
 Forest. Tree 78 1/4" Forest. Árbol 200cm

	White Led Cab. Led Blanco Cab.	RGBW Led Cab. Led RGBW Cab.	RGBW Led Batt. Led RGBW Bat.	DMX Cab. Led RGBW DMX Cab.	DMX Batt. DMX Bateria	Stainless Steel 2 Feet Set Kit 2 Pies Inox
Nano Tree 9 1/4" - Nano Árbol 25cm	49069W	-	49069Y	-	-	-
Tree 19 3/4" - Árbol 50cm	49070W	49070L	49070Y	49070D	49070DY	-
Tree 39 1/4" - Árbol 100cm	49073W	49073L	49073Y	49073D	49073DY	49073X
Tree 59" - Árbol 150cm	49071W	49071L	49071Y	49071D	49071DY	49071X
Tree 78 1/4" - Árbol 200cm	49072W	49072L	49072Y	49072D	49072DY	49072X

Gatsby

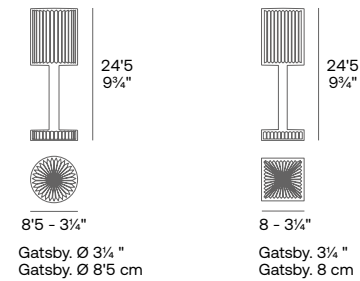

Gatsby. Ø 3 1/4" Gatsby. Ø 8 5/8 cm
 Gatsby. 3 1/4" Gatsby. 8 cm

	White Led Batt. Led Blanco Bat.	RGBW Led Batt. Led RGBW Bat.	DMX Batt. DMX Bateria
Ø 3 1/4" - Ø 8 5/8 cm	54252WY	54252Y	54252DY
3 1/4" - 8 cm	54253WY	54253Y	54253DY

Mora

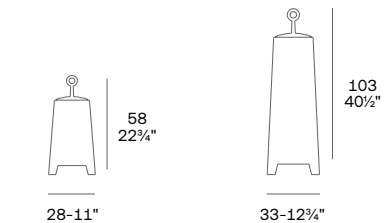

Mora. Lamp 58 Mora. Lámpara 58
 Mora. Lamp 103 Mora. Lámpara 103

	White Led Cab. Led Blanco Cab.	RGBW Led Cab. Led RGBW Cab.	RGBW Led Batt. Led RGBW Bat.	DMX Cab. Led RGBW DMX Cab.	DMX Batt. DMX Bateria
Lamp 58 / Lámpara 58	46028W	46028L	46028Y	46028D	46028DY
Lamp 103 / Lámpara 103	46033W	46033L	46033Y	46033D	46033DY

Jut Chill

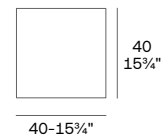

Jut Chill. Lamp Jut Chill. Lámpara

Lamp Lámpara	
White Led Cab. / Led Blanco Cab	44419W
RGBW Led Cab. / Led RGBW Cab.	44419L
DMX Cab. / Led RGBW DMX Cab.	44419D
RGBW Led Batt. / Led RGBW Bat.	44419Y
DMX Batt. / DMX Bateria	44419DY
Hanging Support Kit Kit Soporte Colgante	44419X

Marquis

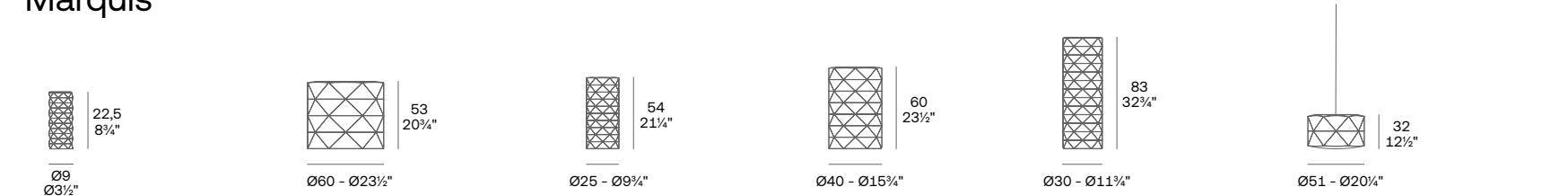

Marquis. Table lamp Ø3 1/2"x8 3/4" Marquis. Lámpara de mesa Ø9x22 1/2
 Marquis. Lamp Ø23 1/2"x20 3/4" Marquis. Lámpara Ø60x53
 Marquis. Lamp Ø9 1/4"x21 1/4" Marquis. Lámpara Ø25x54
 Marquis. Lamp Ø15 1/4"x23 1/2" Marquis. Lámpara Ø40x60
 Marquis. Lamp Ø11 1/4"x32 3/4" Marquis. Lámpara Ø30x83
 Marquis. Hanging Lamp Ø20 1/4"x12 1/2" Marquis. Lámpara colgante Ø51x32

	White Led Cab. Led Blanco Cab.	White Led Batt. Led Bl Bat.	RGBW Led Cab. Led RGBW Cab.	RGBW Led Batt. Led RGBW Bat.	DMX Cab. Led RGBW DMX Cab.	DMX Batt. DMX Bateria
Table Lamp Ø3 1/2"x8 3/4" - Lámpara de mesa Ø9x22 1/2	-	47093WY	-	47093Y	-	47093DY
Lamp Ø23 1/2"x20 3/4" - Lámpara Ø60x53	47087W	-	47087L	47087Y	47087D	47087DY
Lamp Ø9 1/4"x21 1/4" - Lámpara Ø25x54	47088W	-	47088L	47088Y	47088D	47088DY
Lamp Ø15 1/4"x23 1/2" - Lámpara Ø40x60	47089W	-	47089L	47089Y	47089D	47089DY
Lamp Ø11 1/4"x32 3/4" - Lámpara Ø30x83	47090W	-	47090L	47090Y	47090D	47090DY
Hanging Lamp Ø20 1/4"x12 1/2" - Lámpara colgante Ø51x32	47091W	-	47091L	47091Y	47091D	47091DY

Sabinas

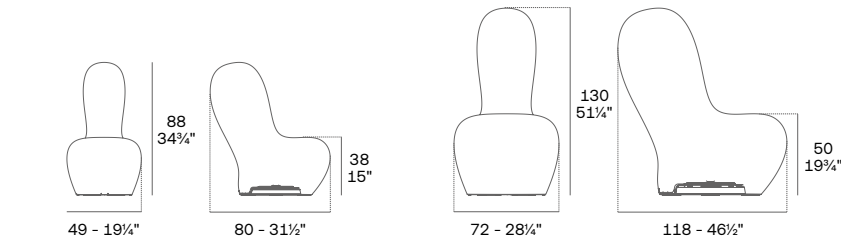

Sabinas. Low Lamp Sabinas. Lámpara Low
 Sabinas. High Lamp Sabinas. Lámpara High

	White Led Cab. Led Blanco Cab.	RGBW Led Cab. Led RGBW Cab.	RGBW Led Batt. Led RGBW Bat.	DMX Cab. Led RGBW DMX Cab.	DMX Batt. DMX Bateria
Low Lamp / Lámpara Low	45011W	45011L	45011Y	45011D	45011DY
High Lam / Lámpara High	45010W	45010L	45010Y	45010D	45010DY

The Factory

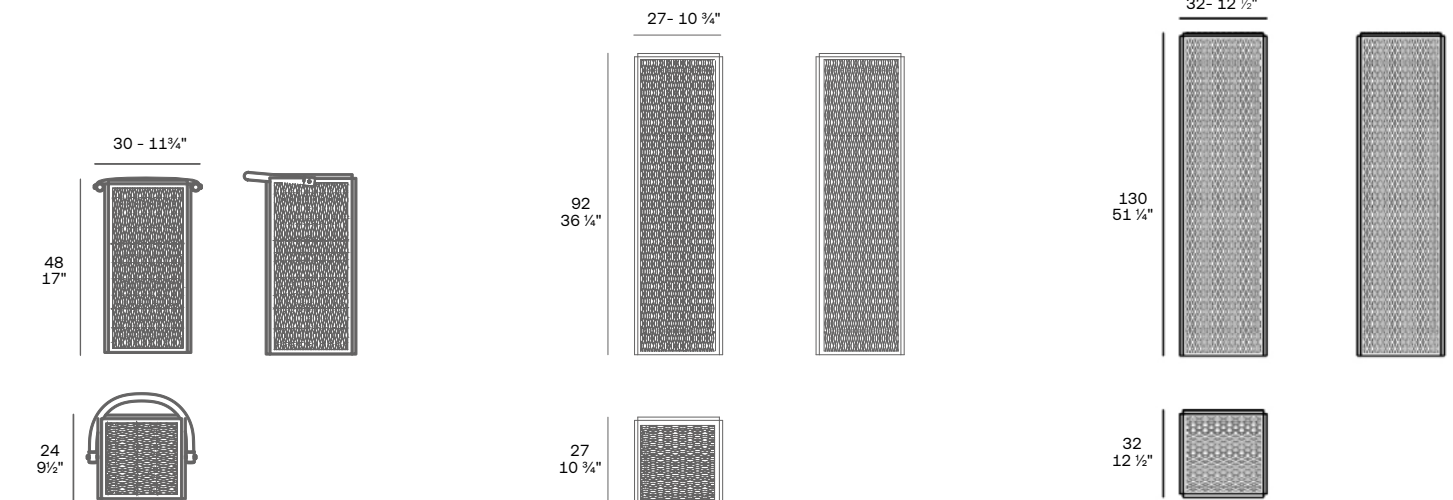

The Factory. Lamp S 11 1/4 X 9 1/4 X 19" The Factory. Lámparas 30 x 24 x 48
 The Factory. Lamp M 10 1/4 X 10 1/4 X 36 1/4" The Factory. Lámparas 27 x 27 x 92
 The Factory. Lámpara 31 x 31 x 120 The Factory. Lamp L 12 1/4 X 12 1/4 X 51 1/4"

The Second Light

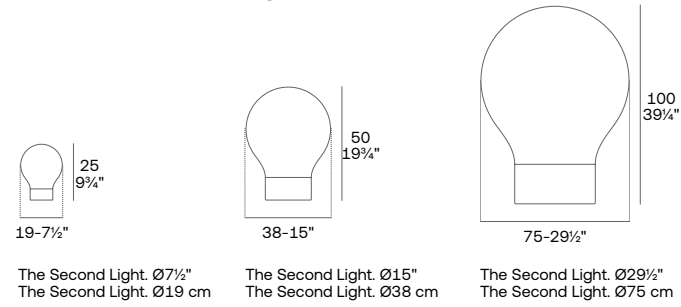

	White Led Cab. Led Blanco Cab.	RGBW Led Cab. Led RGBW Cab.	RGBW Led Batt. Led RGBW Bat.	DMX Cab. Led RGBW DMX Cab.	DMX Batt. DMX Bateria	Hanging Support Kit Kit Soporte Colgante
Ø7 1/2" - Ø19 cm	-	46019L	-	-	-	48000X
Ø15" - Ø38 cm	46038W	46038L	46038Y	46038D	46038DY	48000X
Ø29 1/2" - Ø75 cm	46075W	46075L	46075Y	46075D	46075DY	48000X

Vela

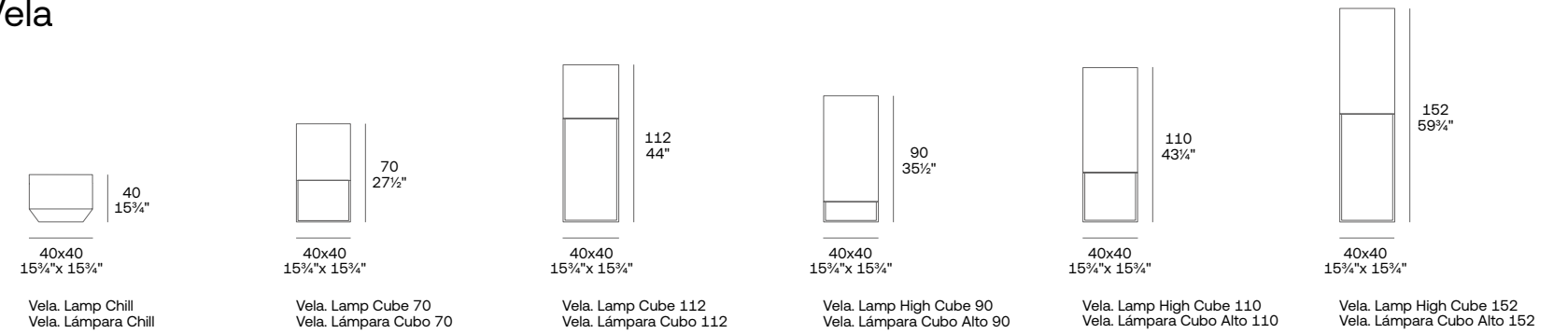

	White Led Cab. Led Blanco Cab.	RGBW Led Cab. Led RGBW Cab.	RGBW Led Batt. Led RGBW Bat.	DMX Cab. Led RGBW DMX Cab.	DMX Batt. DMX Bateria
Lamp Chill - Lámpara Chill	54072W	54072L	54072Y	54072D	54072DY
Lamp Cube 70 - Lámpara Cubo 70	54064W	54064L	54064Y	54064D	54064DY
Lamp Cube 112 - Lámpara Cubo 112	54065W	54065L	54065Y	54065D	54065DY
Lamp High Cube 90 - Lámpara Cubo Alto 90	54066W	54066L	54066Y	54066D	54066DY
Lamp High Cube 110 - Lámpara Cubo Alto 110	54067W	54067L	54067Y	54067D	54067DY
Lamp High Cube 152 - Lámpara Cubo Alto 152	54068W	54068L	54068Y	54068D	54068DY

Vases

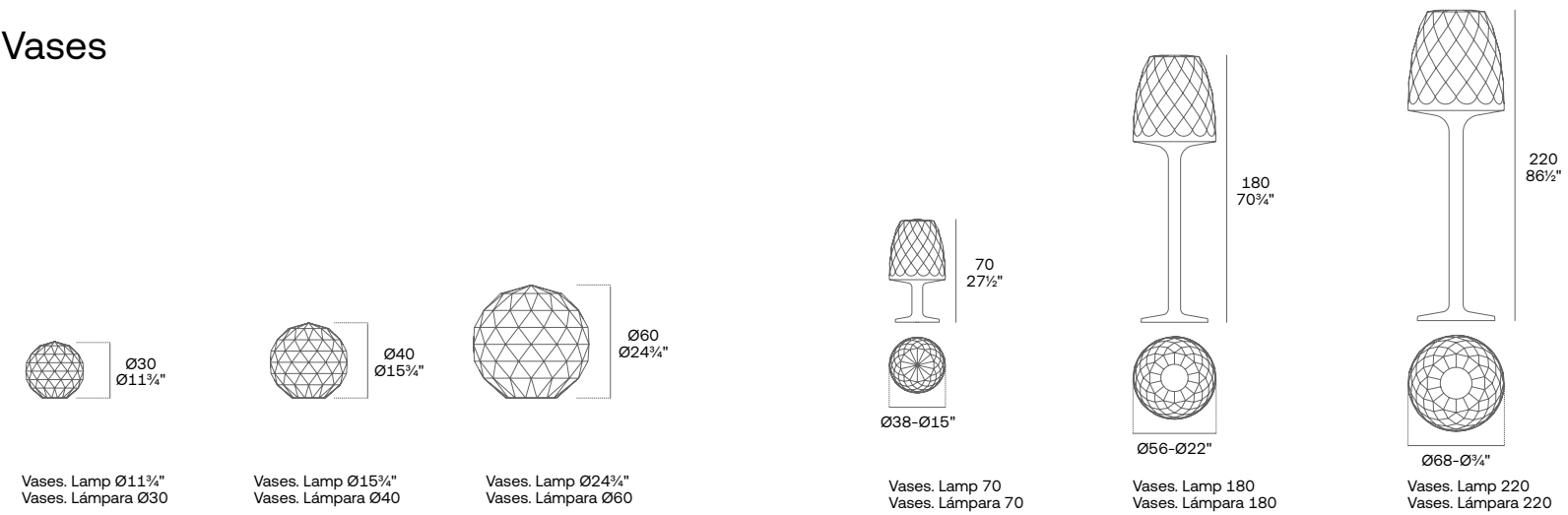

	A in A cm	Ceiling holder kit Kit soporte colgante	White Led Cab. Led Blanco Cab.	RGBW Led Cab. Led RGBW Cab.	RGBW Led Batt. Led RGBW Bat.	DMX Cab. Led RGBW DMX Cab.	DMX Batt. DMX Bateria
Lamp Ø11 1/4" - Lámpara Ø30	Ø11 1/4" - Ø30	48000X	48030W	48030L	48030Y	48030D	48030DY
Lamp Ø15 1/4" - Lámpara Ø40	Ø15 1/4" - Ø40	48000X	48040W	48040L	48040Y	48040D	48040DY
Lamp Ø24 3/4" - Lámpara Ø60	Ø24 3/4" - Ø60	48000X	48060W	48060L	48060Y	48060D	48060DY
Lamp 70 - Lámpara 70	-	-	47038W	47038L	47038Y	47038D	47038DY
Lamp 180 - Lámpara 180	-	-	47056W	47056L	47056Y	47056D	47056DY
Lamp 220 - Lámpara 220	-	-	47068W	47068L	47068Y	47068D	47068DY

Ulm

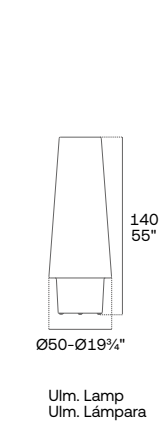

Wing

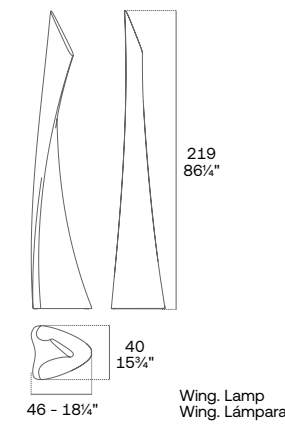

	White Led Cab. Led Blanco Cab.	RGBW Led Cab. Led RGBW Cab.	RGBW Led Batt. Led RGBW Bat.	DMX Cab. Led RGBW DMX Cab.	DMX Batt. DMX Bateria
Ulm. Lamp / Ulm. Lámpara	54110W	54110L	54110Y	54110D	54110DY
Wing. Lamp / Wing. Lámpara	53033W	53033L	53033Y	53033D	53033DY

Technical information



EN | Technical Information

Finishes & Extras / Furniture

All our products are suitable for indoor and outdoor use.

Basic

Matte finish.

Lacquered

High gloss lacquered.

Two-Tone Lacquered

High gloss lacquered finish in two different colors. To avoid possible damage we do not recommend stacking the product.

Extras / Options

White LED

White internally lit unit with LED technology. Available only in matte ice white finish.

RGBW LED

Unit with internal lighting with RGBW LED technology and remote control unit for switching colors. Available only in matte ice white finish. Remote control included.

RGBW LED DMX

Unit with internal lighting with RGBW LED technology and remote control unit for switching colors. Also controlled by DMX-1024 (wireless), enabling communication between one or more products simultaneously via the DMX transmitter (not included). There are two options to choose from: Professional XLR DMX and Home WiFi DMX. Both options are available in various configurations:
1* DMX Wireless Standard Configuration.
2* DMX Wireless Customized Configuration.

With Battery

RGBW LED Battery

Unit with internal lighting with battery-powered RGBW LED technology. Includes charger and remote control for switching colors and charger. Available only in matte ice white finish.

RGBW LED DMX Battery

Unit with internal lighting with RGBW LED technology supplied by a battery (includes charger and remote control unit for switching colors). Also controlled by DMX-1024 (wireless), enabling communication between one or more products simultaneously via the DMX transmitter (not included). There are two options to choose from: Professional XLR DMX and Home WiFi DMX. Both options can have 2 different configurations:
1* DMX Wireless Standard Configuration.
2* DMX Wireless Customized Configuration.

Finishes & Extras / Nanos

Mini products made out of polyethylene resin. Item suitable for indoor and outdoor use.

Nano Basic

Matte finish. The Ice matte finish can be illuminated.

Nano Lacquered

High gloss lacquered.

Extras / Options

Nano White LED

Compact ice-colored unit with white LED lighting. For interior use only.

Nano RGBW LED With Battery (Chrismy)

Compact ice-colored unit with white LED lighting. For interior use only. Charger and batteries included. (Includes remote control unit for changing color).

Finishes & Extras / Pots & Planters

Pots and planters made out of a single walled polyethylene resin. Item suitable for outdoor use.

Simple

Matte finish.

Lacquered Simple

High gloss lacquered.

Basic

Matte finish.

The Ice matte finish can be illuminated.

Self-Watering System

This system provides the plant with water whenever the plant needs it, this mechanism has an indicator that alerts us when the plant needs to be watered. Available in matte and lacquered finishes only for indoor use. Not recommended for outdoors. Due to the drainage, the indicator will not work properly.

Lacquered

High gloss lacquered.

This self-watering system is included in the basic finish collections.

Extras / Options

White LED

White internally lit unit with LED technology. Available only in matte ice white finish.

RGBW LED

Unit with internal lighting with RGBW LED technology and remote control unit for switching colors. Available only in matte ice white finish. Remote control included.

RGBW LED DMX

Unit with internal lighting with RGBW LED technology and remote control unit for switching colors. Also controlled by DMX-1024 (wireless), enabling communication between one or more products simultaneously via the DMX transmitter (not included). There are two options to choose from: Professional XLR DMX and Home WiFi DMX. Both options are available in various configurations:
1* DMX Wireless Standard Configuration.
2* DMX Wireless Customized Configuration.

With Battery

RGBW LED Battery

Unit with internal lighting with battery-powered RGBW LED technology. Includes charger and remote control for switching colors and charger. Available only in matte ice white finish.

RGBW LED DMX Battery

Unit with internal lighting with RGBW LED technology supplied by a battery (includes charger and remote control unit for switching colors). Also controlled by DMX-1024 (wireless), enabling communication between one or more products simultaneously via the DMX transmitter (not included). There are two options to choose from: Professional XLR DMX and Home WiFi DMX. (Remote control included). Both options can have 2 different configurations:
1* DMX Wireless Standard Configuration.
2* DMX Wireless Customized Configuration.

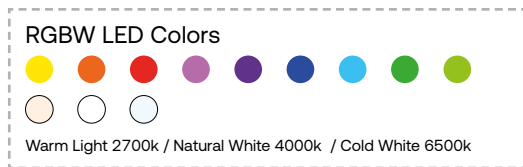

Bluetooth Sound System ✳

Connect your smartphone or tablet via Bluetooth to the built in speakers.

- Sound systems 200W Dual component.

- Bluetooth Ready v.4.0.

- Input: AUX Jack 3,5 mm.

- USB Charger for portable gadget - Output 5V= 1500mA

Lighting

Power Supply

LED White

- Simple color LEDs 4500 K

- 720 - 2800 LM Max. (Models subject to availability)



- 12 - 72 W Max. (Models subject to availability)

- Power supply: Mean Well / Class 2 / IN: 100-240V AC / 50-60Hz

- IEE: Class A

- IP65 / applicable for wet areas.

- Ta: 40°C

- 4-5 m. white cable Ho5RN-F 2G1 mm2 + Plug (EU - AUS - UK)   

- 4-5 m. white cable SJTW - 2 x AWG18 + Plug (USA) 

- CE / RoHS / UL



Nano LED White

- Simple color LEDs 4500 K

- 40 LM

- 1.4 W Max.

- Wall Power supply: IN: 100-240V AC / 50-60Hz

- IEE: Class A

- IP20 / indoor use only

- Ta: 35°C

- 2 Meters transparent cable with hand switch + EU Plug 

- CE / RoHS

RGBW LED

- Multicolor LEDs RGBW

- Controller RF433 Mhz / 10-15 meters range

- 450 - 1100 LM Max. (Models subject to availability)



- 16 - 72 W Max. (Models subject to availability)

- Power supply: Mean Well / Class 2 / IN: 100-240V AC / 50-60Hz

- IEE: Class A

- IP65 / applicable for wet areas.

- Ta: 40°C

- 4-5 m. white cable Ho5RN-F 2G1 mm2 + Plug (EU - AUS - UK)   

- 4-5 m. white cable SJTW - 2 x AWG18 + Plug (USA) 

- CE / RoHS / UL



RGBW LED DMX

- Multicolor LEDs RGBW

- Controller RF433 Mhz / 10-15 meters range

- DMX 1024 decoder / 2.4Ghz wireless signal/ compatible with IOS or Android & Professional Installations.

- DMX 1024 decoder / 2.4 Ghz wireless signal.

-Home WiFi DMX wireless controller, compatible with IOS and Android (not included)

-Professional DMX wireless controller, connector XLR (not included)

- 450 - 1100 LM Max. (Models subject to availability)



- 12 - 72 W Max. (Models subject to availability)

- Power supply: Mean Well / Class 2 / IN: 100-240V AC / 50-60Hz

- IEE: Class A

- IP65 / applicable for wet areas.

- Ta: 40°C

- 4-5 m. white cable Ho5RN-F 2G1 mm2 + Plug (EU - AUS - UK)   

- 4-5 m. white cable SJTW - 2 x AWG18 + Plug (USA) 

- CE / RoHS / UL



Battery

Battery RGBW LED

- Multicolor LEDs RGBW

- Controller RF433 Mhz / 10-15 meters range

- 450 - 1100 LM Max. (depending on the model)

- 12 - 72 W Max. (depending on the model)

- Li-ion Battery 5.2 19 Ah (depending on the model) 12V / 6-8 h autonomy / Load 5h - 500 cycles

- Charger: 1,5A - 4A (depending on the model) IN: 100-240V AC / 50-60Hz

- IEE: Class A / CE / RoHS / IP65 (Suitable for wet areas)

- Ta: 40°C

Battery RGBW LED DMX

- Multicolor LEDs RGBW

- Controller RF433 Mhz / 10-15 meters range

- DMX 1024 decoder / 2.4 Ghz wireless signal.

-Home WiFi DMX wireless controller, compatible with IOS and Android (not included)

-Professional DMX wireless controller, connector XLR (not included)

- Li-ion Battery 5.2 - 19 Ah (depending on the model) 12V / 6-8 h autonomy / Load 5h - 500 cycles

- Charger: 1,5A - 4A (depending on the model) IN: 100-240V AC / 50-60Hz

- 1100 LM Max. (Models subject to availability)

- 12 - 72 W Max. (Models subject to availability)

- IEE: Class A / CE / RoHS / IP65 (Suitable for wet areas)

- Ta: 40°C

Battery Nano LED RGBW

- Multicolor LEDs

- Controller RF433 Mhz / 10-15 meters range

- 40 - 100 LM Max.

- 1.5 W Max.

- Li-ion Battery 2 Ah / 5V / 6-8 h autonomy / Load 5h / IN: 100-240V AC / 50-60Hz

- IEE: Class A / CE / RoHS / IP65 (Suitable for wet areas)

- Ta: 40°C

Led White / Table Lamps

- Single LED Warm White 2700k²

- ON/OFF & Dimmer tactile

- 0.8W (Battery) - 3.3 W Max. (Power supply).

- Li-ion Battery 3000 mA 4.2V / 12 h autonomy / Load 4h - 500 cycles

- USB Charger 5v DC 1A / IN: 100-240V AC / 50-60Hz

- Ta: 40°C

- IEE: Class A++ / IP54 / CE

RGBW LED / Table Lamps

- 5 LEDs Colors. (Blue / Fucsia / Amber / Turquoise / Warm White 2700k²)

- ON/OFF & Dimmer tactile

- 0.8W (Battery) - 3.3 W Max. (Power supply).

- Li-ion Battery 3000 mA 4.2V / 12 h autonomy / Load 4h - 500 cycles

- USB Charger 5v DC 1A / IN: 100-240V AC / 50-60Hz

- Ta: 40°C

- IEE: Class A+ / IP54 / CE

RGBW LED DMX / Table Lamps

- 5 LEDs Colors. (Blue / Fucsia / Amber / Turquoise / Warm White 2700k²)

- ON/OFF & Dimmer tactile

- DMX 1024 decoder / 2.4 Ghz wireless signal.

-Home WiFi DMX wireless controller, compatible with IOS and Android (not included)

-Professional DMX wireless controller, connector XLR (not included)

- 0.8W (Battery) - 3.3 W Max. (Power supply).

- Li-ion Battery 3000 mA 4.2V / 12 h autonomy / Load 4h - 500 cycles

- USB Charger 5v DC 1A / IN: 100-240V AC / 50-60Hz

- Ta: 40°C

- IEE: Class A+ / IP54 / CE



EN | Technical Information

Material / Features

Polypropylene

- Material: Polypropylene resin with glass fiber , UV stabilizer.
- Process: injection moulding.
- Shock resistant.
- Light weight.
- 100% recyclable.

Polyethylene

- Material: Resin. Linear low-density poethylene. UL94 HB.
- Process: Rotational Moulding.
- Resistant to UVl. Fattore UV8, equivalent to 8.000 hours of Florida sunlight.
- Resistant to extreme temperatures (-60°C to + 80°C) / (-76°F to 176°F)
- Shock Resistant.
- Light weight
- The planters are easily drilled to make draining holes.
- Recyclable 100%.

Polycarbonate

- Material: Polycarbonate resin. Low viscosity, high strength.
- Process: Injection Moulding.
- Shock Resistant.
- Light weight
- Recyclable 100%.

Aluminium (table base)

- Material: AISI12 (EN AC-44100).
- Process: Cast aluminum.
- Shock Resistant.
- Recyclable 100%.
- Powder coated cast aluminum.

Aluminum (profile)

- Material: 6060 (AlMgSi,3.3206,A96060).
- Process: Aluminum extrusion.
- Shock Resistant.
- Recyclable 100%.
- Lacquered.

Teak Wood

- Premium Indonesian teak is durable and exceptionally resistant to the elements
- Natural Teak weathers to a soft, silver-grey patina over time due to the effects of sun and moisture
- Please check the web for maintenance and care of teak

Weathered Teak Wood

- Premium Indonesian teak is durable and exceptionally resistant to the elements
- Weathered Teak's hand-applied, wire-brush finish offers an already weathered look
- Please check the web for maintenance and care of teak

Padded Foam

Polyurethane foam is suitable for outdoor use and in areas with high humidity. Perfectly waterproof, high drying capacity, comfortable and easily cleaned.

Properties	Unit	Value	Specifications
Composition	-	100% Polyester	-
Maximum temperature	°C	110.0	±1.0
Manufacturing process	Dry carded and termal drying		
Recyclability	100%, without additives or binding agents		

Other caracterhics:

- It does not absorb or retain moisture.
- It is not affected by mould, insects or rodents.
- It does not cause irritation to the skin or the mucous membranes.

Polyurethane Foam (Upholstered Furniture)

Furniture made produced with Polyurethane foam injected. The foam has high resilience and durability. The flexible Polyurethane foam is covered with a elastic cellular net that keeps the original product's shape after its use. Prevents fungal and bacterial growth.

Mechanical properties.

- Tensile strength resistance: between 3 & 10 (Kp/cm2)
- Compression resistance: between 1,5 & 9 (Kp/cm2)
- Shear strength resistance: between 1 & 5 (Kp/cm2)
- Modulus of elasticity: between 40 & 200 (Kp/cm2)

Table Tops / Features

DEKTON®

Ceramic surface with high resistance, suitable for indoor and outdoor use.

				Kelya	Entzo	Danae
Flexural tensile strength or modulus of rupture	UNE EN ISO 10545-4	Average flexural resistance	N/mm2	46	45	55
		Average break load	N	2548	2313	2356
		Average break strength	N	14966	13559	13818
Water absorption, apparent porosity, density	UNE EN ISO 10545-3	Water absorption by boiling	%	0	0,1	0,1
		Water absorption by vacuum	%	0,1	0,1	0,1
		Open porosity	%	0,2	0,2	0,2
		Aparent relative density	g/cm3	2,51	2,61	2,53
Aparent density	g/cm3	2,50	2,61	2,52		
Resistance to deep abrasion	UNE EN ISO 10545-6	Wear volume	mm3	125	106	115
Impact resistance	UNE EN ISO 10545-5	Coefficient of restitution (COR)	-	0,85	0,85	0,85
Determination of linear thermal expansion	UNE EN ISO 10545-8	Expansion 30-100°C	°C-1	6,5 · 10-6	5,1 · 10-6	6,3 · 10-6
Thermal shock resistance	UNE EN ISO 10545-9	Damage	-	ULA (no damage)	ULA (no damage)	ULA (no damage)
Moisture expansion	UNE EN ISO 10545-10	Expansion max	mm/m	0,1	0,1	0,1
		Expansion mid	mm/m	0,0	0,0	0,0
Frost resistance	UNE EN ISO 10545-12	Damage	-	ULA (no damage)	ULA (no damage)	ULA (no damage)

HPL / Solid Core

HPL Tabletops for Mari-sol, Faz and Delta table bases thickness is 10mm ± 0,55.

Thickness	ISO 4586 ½	mm	13 ± 0,55	
Density	ISO 1183	Kg/m3	1400 - 1500	
Absorción de agua	ISO 4586 ½	%	Weight	2,0 max.
			Thickness	2,0 max.
Estabilidad dimensional a altas temperaturas	ISO 4586 ½	%	Long.	0,25 max.
			Trans.	0,55 max.
Hardness	ASTM D 785	HR E	97 ca	
Resistencia a la flexión	ISO 178	MPa	Long.	145 min
			Trans	135 min

Glass

Security tempered glass. Thickness: 10 mm.

Technical Features	Units	Value
Resistant to soft body impact		2(B)2
Resistance against suddne temperature changes	K	40
Resistant to wind, snow and large weight	mm	10
Sound insulation	dB	34 (-1,-3)
Thermal Properties		
Thermal Transmittance (value U)	W/(m2.K)	5.6
Light Transmission tV		0.53
Light Refletion pV		0.06/0.06
Solar Transmission tE		0.52
Solar Reflection pE		0.06/0.06

Fabrics / Features

Fabric	Weight Peso	Flame Resistance	Resistance	Color Fastness	Composition	Maintenance	Symbols
Nautical. Soft acrylic outdoor fabric with leather-like texture.	657 gr/m2	EN 1021 1-2 DIN 4102 B2 BS 5852 DIN 53438/T2 CAL TB 117	>100.000 cycles	XENOTEST DIN 54004/ NTC 1479 ASTM D-4329/ CFFA-2 c2	Vinyl Coating, 100% Polyester Backing	Clean using a cotton cloth with neutral soap 1/9 water solution. Rub dry with a clean cloth and let dry.	
Silvertex. Soft-shiny acrylic outdoor fabric.	685 gr/m2	EN 1021 1-2 DIN 4102 B2 NF P 92-503 / M2 UNE 23.727-90 IR/ M2 IMO MSC.307 CAL TB 117	>300.000 cycles	>7 - DIN 54004 NTC 1479 (UV outdoor) 4 - ISO 105B04	Vinyl Coating, 100% Polyester Backing	Clean using a cotton cloth with neutral soap 1/9 water solution. Rub dry with a clean cloth and let dry.	
Savane. An irregular weave reveals its textural beauty. Suited naturally to all outdoor furnitures.	400 gr/m2	CAL TB 117 NFPA 260 UFAC - Class I	50.000 cycles	(UV indoor) 8/8 - ISO 105B02 (UV outdoor) 4-5 - ISO 105B04	100% Acrylic	Clean using a cotton cloth with 1/5 household bleach solution. Remove all bleach residues with water. Rub dry with a clean cloth and let dry.	
Dralon. Basic acrylic outdoor fiber for contract products' cushions.	185 gr/m2	BS5852 0/1 UNE 1021 1 BS7176 Low hazard	25.000 cycles	(UV indoor) 6-7/8 - ISO 105B02 (water) 5 - ISO 105E03/02/01	100% Acrylic	Clean using a cotton cloth with neutral soap solution. Rub dry with a clean cloth and let dry.	
Crevin. Upholstery fabric with a medium size and elegant weave. 40% made with recycled PET.	520 gr/m2	EN 1021 1 BS5852 0/1 CAL TB 117 NFPA 260	60.000 cycles	(water) 4-5 - ISO 105E03/02/01 (UV outdoor) >6 - ISO 105B04	40% Recycled PET 60% PP	Clean using a cotton cloth with 1/5 household bleach solution. Remove all bleach residues with water. Rub dry with a clean cloth and let dry.	
Heritage. Made using 50% of recycled plastics.	335 gr/m2	BS5852 0/1 UNE 1021 1 BS7176 Low hazard	25.000 cycles	(UV indoor) 7-8/8 - ISO 105B02 (UV outdoor) 5/5 - ISO 105B04	50% Recycled acrylic, 47% Sunbrella acrylic, 3% PE	Clean using a cotton cloth with neutral soap solution. Rub dry with a clean cloth and let dry.	
Velum. Lightweight and semi-transparent fabrics for curtains. .	165 gr/m2	-	-	(UV indoor) 8/8 - ISO 105B02 (UV outdoor) 4-5 - ISO 105B04	100% Acrylic	Clean using a cotton cloth with 1/5 household bleach solution. Remove all bleach residues with water. Rub dry and let dry.	
Batyline. breathable acrylic mesh used on sun loungers and sunroofs.	500 gr/m2	EN 1021 1-2 EN 13501 - 1 DIN 4102 B1 NFP 92-507 CAL TB 117 IMO MSC 307	>120.000 cycles	4/5 ASTM G154	Polyester fibre protected with PVC coating.	Wash the mesh with a mild liquid detergent and fresh water, using a soft bristle brush. Batyline mesh has anti-fungal treatment where the moist will have no effect on it.	
Cico. Cozy fabric with an elegant look and soft touch.	423 gr/m2	BS5852 0/1	25.000 cycles	(UV indoor) 7/8 - ISO 105B02 (UV outdoor) 4/5 - ISO 105B04	100% Polypropylene	Clean using a cotton cloth with neutral soap solution. Rub dry with a clean cloth and let dry.	
Siesta. Cozy fabric with an elegant look and soft touch.	500 gr/m2	TB117-2013 UNE 1021 1	60.000 cycles	-	100% Polypropylene	Clean using a cotton cloth with neutral soap solution. Rub dry with a clean cloth and let dry.	
Acapulco. Cozy fabric with an elegant look and soft touch.	500 gr/m2	TB117-2013 UNE 1021 1	>30.000 cycles	-	100% Polypropylene	Clean using a cotton cloth with neutral soap solution. Rub dry with a clean cloth and let dry.	
Ikon 36. Cozy fabric with an elegant look and soft touch.	650 gr/m2	TB117-2013 UNE 1021 1	30.000 cycles	-	100% Polypropylene	Clean using a cotton cloth with neutral soap solution. Rub dry with a clean cloth and let dry.	
Krollet. Elegant fabric with a pleasant touch and great comfort.	985 gr/ml	-	40.000 cycles	-	94% PP + 6% PC S.D.		
Varm. Cozy fabric with a pleasant touch and great comfort.	850 gr/m2	cigarette test: BS5852 part 1,(1990)	60.000 cycles	Factor 7UV UNI EN ISO 20105-B02	100% Polypropylene	The whashing podwer should not contain oxidizing agents o brightening agents. In case of dropped liquid or water on the fbric remove all spills immediately but not the rub. Gently blot liquid spills with a clean dry cloth	
Hygge. Cozy fabric with a pleasant touch and great comfort.	910 gr/m2	cigarette test: BS5852 part 1,(1990)	60.000 cycles	Factor 7UV UNI EN ISO 20105-B02	100% Polypropylene		
Glad. Premium fabric with a wide range of colours	975 gr/m2	cigarette test: BS5852 part 1,(1990)	30.000 cycles	Factor 7UV UNI EN ISO 20105-B02	100% Polypropylene		

EN | Technical Information

DMX Wireless

DMX 512 (Digital Multiplex) is a mechanism used for the electronic control of entertainment lighting, enabling communication between the control-table, our own lights and light sources. You can create customized and special environments. This allowed to control every Vondom product independently or in groups.

There are 2 different DMX Wireless, depending on our customer needs:

DMX Wireless Professional XLR Pack

Vondom DMX Wireless Professional XLR you can control all LED RGBW VONDOM pieces from your Mix Tables, PC+software, Domotic panels, etc.

1* DMX Wireless Standard Configuration
Preset three separate Family products: POTS, LAMPS & FURNITURE.

2* DMX Wireless Customized Configuration
You can send us your customized special environment that you want to control independently and we will set it up.

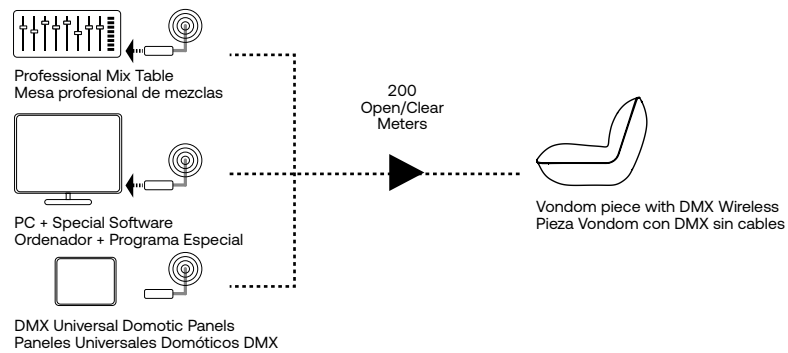

2* Example of DMX Wireless Professional Customized Configuration

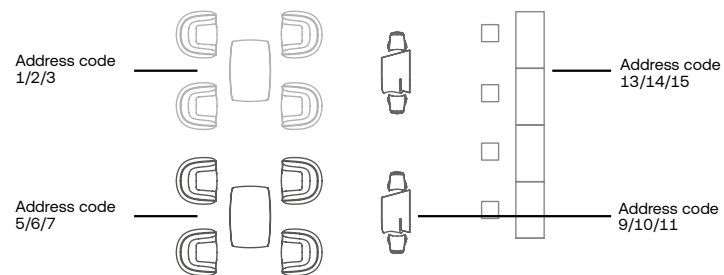

DMX IS FUN!

DMX Wireless Home Wifi Pack

Vondom DMX Wireless Home Wi-Fi Pack is a Wi-Fi access point to control all LED RGBW VONDOM items with your IOS or Android devices.

1* DMX Wireless Standard Configuration
Preset three separate Family products: PLANTERS, LAMPS & FURNITURE.

2* DMX Wireless Customized Configuration
You can send us your customized requirements in order to control individually each item/group and we will set it up. (Max. 8 rooms).

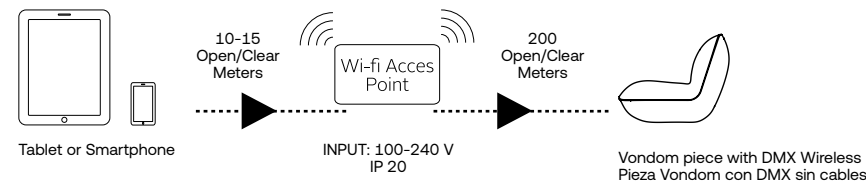

2* Example of DMX Wireless Home Customized Configuration

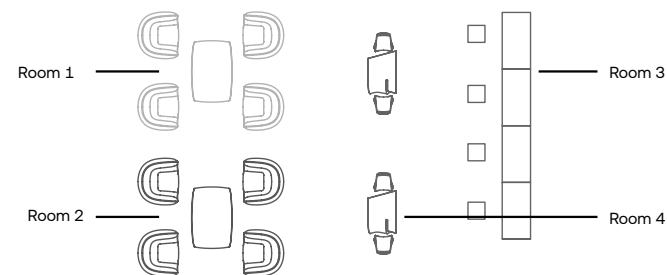

Maintenance & Safety / General

Our productions are manufactured according to ISO 9001:2008 quality and ISO 14001:2004 environmental quality, by using high quality materials we guarantee long life of our products.

In order to provide a durable and safe use to the product, please follow the following recommendations:

- Continuous exposure to the sun (especially with the dark colors) can cause burning injuries by direct contact with your skin. To avoid this, please check the temperature of the furniture in case of long-term exposure to the sun.

- Place the item on a flat surface to avoid uncontrolLED movements.

- Keep the item far from excessive heat sources.

- The product is not a toy. To avoid accidents, do not to allow children to play with it.

- Keep furniture away dust to keep it clean, if cleaning is be required we recommended the use of pressure washers, such as KARCHER'S and/or domestic degreasing cleaner periodically. Never use abrasive or corrosive products.

- To preserve the product, we recommend the usage of VONDOM cover for every item.

- In the case of lacquered products, we recommended car wax every 2 or 3 months, as it will avoid the appearance of possible scratches.

- Outdoor cushions are available only some models. We recommended you clean them periodically with a cloth and basic soap and water.

- Clean the stainless steel parts with appropriate products.

- When changing bulbs, please make sure the cord is not connected to the main power.

- If cords suffer any damage, they must be changed exclusively by the manufacturer or by a professional.

- If the RGBW LED stops working, please do not handle it. Contact the manufacturer or your distributor immediately.



Cleaning / General

Vondom Outdoor Furniture cleans easily and stays impeccable.

Steps for clean outdoor furniture:

1. Spray the degreaser over the dirty surface.
2. Rub it with a damp cloth.
3. Rinse with abundant water with pressure washer.

Cautions! Don't use pressure washer for cushions and lacquered finish items.

4. Dry it outside and enjoy our products.

We hope you enjoy our products. If you need any further information, please contact our CUSTOMER SERVICE department by calling **+34 96 239 84 86** or sending us an e-mail to **info@vondom.com**.

Remote Control Instructions

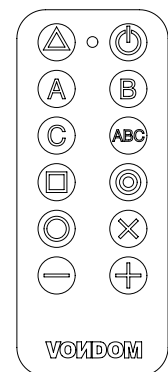

- △ Repeat last order (Re-send order)
- ⏻ ON / OFF
- A/B/C Groups (A = Furniture and furnishings / B = Planters & Pots / C = Lamps) can be customized, 3 maximum items.
- ABC Controls all groups simultaneously
- Automatic color change
- Memory Button (for programming custom colors) (consult "advanced functions")
- Programmed colors
- ⊗ Warm White 2700K / Natural White 4000k / Cool White 6500k
- +/- More / less (speed or intensity)

- Remote Control Battery: CR2032
- RF Controller: 433 Mhz / 10-15 meters (30-45 feet) range
- IP20 / indoor use only.

Key Icons

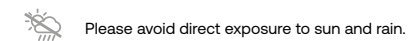

ES | Información Técnica

Acabados y Extras /Mobiliario

Simple

Acabado mate.

Lacado 

Acabado lacado brillo.

Bicolor Lacado 

Acabado lacado brillo en dos colores diferentes. Para evitar posibles daños no se recomienda apilar el producto.

Extras/Opciones

Led Blanco

Mobiliario con iluminación de color blanco mediante tecnología LED. Solo disponible en acabado hielo mate.

RGBW Led

Mobiliario con iluminación interior mediante tecnología LED RGBW y mando a distancia para cambiar de color. Solo disponible en acabado hielo mate.

RGBW Led DMX

Mobiliario con iluminación interior mediante tecnología LED RGBW y mando a distancia para cambiar de color. Controlado también por DMX-1024 (wireless), permitiendo la comunicación entre uno o multiples productos simultaneamente mediante el transmisor DMX (no incluido). Hay dos opciones para seleccionar. Professional XLR DMX y Home WIFI DMX.

- 1* DMX Wireless configuración estandar.
- 2* DMX Wireless configuración personalizable según el cliente.

Con Batería

RGBW Led Battery

Mobiliario con iluminación interior mediante tecnología LED RGBW, alimentado por una batería. Se incluye mando a distancia para cambiar de color y cargador. Solo disponible en acabado hielo mate.

RGBW Led DMX Battery

Mobiliario con iluminación interior mediante tecnología LED RGBW, alimentado por una batería (incluye cargador y mando a distancia para cambio de color). Controlado por DMX-1024 (wireless), permitiendo la comunicación entre uno o multiples productos simultaneamente mediante el transmisor DMX (no incluido). Hay dos opciones para seleccionar: Professional XLR DMX y Home WIFI DMX. Ambas opciones disponen de varias configuraciones:

- 1* DMX Wireless configuración estandar.
- 2* DMX Wireless configuración personalizable según el cliente.

Acabados y Extras /Nanos

Producto de dimensiones reducidas fabricado en resina de polietileno, con doble pared. Producto apto para exterior e interior.

Nano Basic

Acabado mate.

Nano Lacado 

Acabado lacado brillo.

Extras/Opciones

Nano Led Blanco

Producto de dimensiones reducidas color hielo con iluminación LED de color blanco. Sólo para interiores.

Nano Led RGBW Con Batería (Chrismy)

Producto de dimensiones reducidas color hielo con iluminación mediante tecnología Led RGBW. Solo para interi-ores. Cargador y batería incluidos. (Incluye mando para cambiar de color).

66

Acabados y Extras /Maceteros y Jardineras

Simple

Acabado mate.

Simple Lacada 

Acabado lacado brillo.

Basic

Macetero acabado mate.

Autorriego

Macetero acabado mate con sistema de autorriego.

Lacado 

Macetero acabado lacado brillo con sistema de autorriego.

Extras/Opciones

Led Blanco

Maceta con sistema de autorriego con iluminación interior de color blanco mediante tecnología LED. Solo disponible en acabado hielo mate.

RGBW Led

Maceta con sistema de autorriego, que incluye iluminación interior mediante tecnología LED RGBW y mando a distancia para cambiar de color. Solo disponible en acabado hielo mate.

RGBW Led DMX

Maceta con sistema de autorriego, que incluye iluminación interior mediante tecnología LED RGBW y mando a distancia para cambiar de color. Controlado por DMX-1024 (wireless), permitiendo la comunicación entre uno o multiples productos simultaneamente mediante el transmisor DMX (no incluido). Hay dos opciones para seleccio-nar. Professional XLR DMX y Home WIFI DMX. Ambas opciones disponen de varias configuraciones:

- 1* DMX Wireless configuración estandar.
- 2* DMX Wireless configuración personalizable según el cliente.

Con Batería

RGBW Led Battery

Maceta con sistema autorriego, que incluye iluminación interior mediante tecnología LED RGBW, alimentado por una batería. Se incluye mando a distancia para cambiar de color y cargador. Solo disponible en acabado hielo mate.

RGBW Led Dmx Battery

Maceta con sistema autorriego, que incluye iluminación interior mediante tecnología LED RGBW, alimentado por una batería (incluye cargador y mando a distancia para cambio de color). Controlado por DMX-1024 (wireless), permitiendo la comunicación entre uno o multiples productos simultaneamente mediante el transmisor DMX (no incluido). Hay dos opciones para seleccionar: Professional XLR DMX y Home WIFI DMX. Ambas opciones disponen de varias configuraciones:

- 1* DMX Wireless configuración estandar.
- 2* DMX Wireless configuración personalizable según el cliente.



Bluetooth Sound System ✱

Conecta tu smartphone o tablet a los altavoces integrados en el mobiliario Vondom por Bluetooth.

- Sound systems 200W Dual component.
- Bluetooth Ready v. 4.0.
- Entrada: AUX Jack 3,5 mm.
- USB de carga para cualquier dispositivo portátil
- Salida 5V= 1500mA

Iluminación /Información técnica

Fuente de Alimentación



Led Blanco

- Color simple LEDs 4500 K
- 720 - 2800 LM Máx. (según modelos)
- 12 - 72 W Máx. (según modelos)
- Fuente de alimentación: Mean Well / Class 2 / IN: 100 - 240V AC / 50 - 60Hz

- IEE: Class A

- IP65 / aplicable para zonas húmedas

- Ta: 40°C

- 4-5 m. de cable Blanco Ho5RN-F 2G1 mm2 + Clavija (EU - AUS - UK)   

- 4-5 m. de cable Blanco SJTW - 2 x AWG18 + Clavija (USA) 

- CE / RoHS / UL



Nano Led Blanco

- Color simple LEDs 4500 K

- 40 LM

- 1.4 W Máx.

- Fuente de alimentación de pared: IN: 100-240V AC / 50-60Hz

- IEE: Clase A

- IP20 / Aplicable para interiores

- 2 m. de cable Transparente con interruptor de mano + Clavija EU 

- Ta: 35°C

- CE / RoHS

Led RGBW

- Multicolor LEDs RGBW

- Controlador RF433 Mhz / 10-15 metros de alcance

- 450 - 1100 LM Máx. (según modelos)



- 12 - 72 W Máx. (según modelos)

- Fuente de alimentación: Mean Well / Class 2 / IN: 100-240V AC / 50-60Hz

- IEE: Clase A

- IP65 / Aplicable para zonas húmedas

- Ta: 40°C

- 4-5 m. de cable Blanco Ho5RN-F 2G1 mm2 + Clavija (EU - AUS - UK)   

- 4-5 m. de cable Blanco SJTW - 2 x AWG18 + Clavija (USA) 

- CE / RoHS / UL



Led RGBW DMX

- Multicolor LEDs RGBW

- Controlador RF433 Mhz / 10-15 metros de alcance

- Decodificador DMX 1024 / Señal sin cables 2.4 Ghz
- Controlador Home WIFI DMX Sin Cables, compatible con IOS y Android (no incluido)

- Controlador Profesional DMX Sin Cables, conector XLR (no incluido)

- 450 - 1100 LM Máx. (según modelos)



- 12 - 72 W Máx. (según modelos)

- Fuente de alimentación: Mean Well / Class 2 / IN: 100-240V AC / 50-60Hz

- IEE: Clase A

- IP65 / Aplicable para zonas húmedas

- Ta: 40°C

- 4-5 m. de cable Blanco Ho5RN-F 2G1 mm2 + Clavija (EU - AUS - UK)   

- 4-5 m. de cable Blanco SJTW - 2 x AWG18 + Clavija (USA) 

- CE / RoHS / UL



Con Batería

Led RGBW Batería

- Multicolor LEDs RGBW

- Controlador RF433 Mhz / 10-15 metros de alcance

- 450 - 1100 LM Máx. (según modelos)

- 12 - 72 W Máx (según modelos)

- Batería Li-ion 5.2 - 19 Ah (según modelos) 12V / 6-8 h autonomía / Carga 5h - 500 ciclos /

- Cargador 1,5A - 4A (segun modelos) IN: 100-240V AC / 50-60Hz

- CE / RoHS / IP65 (Aplicable para zonas húmedas)

- Ta: 40°C

Led RGBW DMX + Batería

- Multicolor LEDs RGBW

- Controlador RF433 Mhz / 10-15 metros de alcance

- Decodificador DMX 1024 / Señal sin cables 2.4 Ghz
- Controlador Home WIFI DMX Sin Cables, compatible con IOS y Android (no incluido)
- Controlador Profesional DMX Sin Cables, conector XLR (no incluido)

- 450 - 1100 LM Máx. (según modelos)

- 12 - 72 W Máx (según modelos)

- Batería Li-ion 5.2 - 19 Ah (según modelos) 12V / 6-8 h autonomía / Carga 5h - 500 ciclos /

- Cargador 1,5A - 4A (segun modelos) IN: 100-240V AC / 50-60Hz

- CE / RoHS / IP65 (Aplicable para zonas húmedas)

- Ta: 40°C

Nano Led RGBW Batería

- Multicolor LEDs RGBW

- Controlador RF433 Mhz / 10-15 metros de alcance

- 40 - 100 LM Máx - 1.5 W Máx

- Batería Li-ion 2 Ah / 5V / 6-8 h autonomía / Carga 5h /

- Cargador 0,5A IN: 100-240V AC / 50-60Hz

- CE / RoHS / IP65 (Aplicable para zonas húmedas)

- Ta: 40°C

Led Blanco/Lámparas De Mesa

- LED Blanco cálido 2700kº

- ON/OFF y Control de intensidad táctil

- 0.8W (Con batería) - 3.3 W Max. (Conectado a la corriente).

- Batería Li-ion 3000 mA 4.2V / 12 h autonomía / Carga 4h - 500 ciclos

- Cargador USB 5v DC 1A / IN: 100-240V AC / 50-60Hz

- Ta: 40°C

- IEE: Clase A++ / IP54 / CE

RGBW Led/Lámparas De Mesa

- 5 LEDs Colors. (Azul / Fucsia / Ámbar / Turquesa / Blanco cálido 2700kº)

- ON/OFF y Control de intensidad táctil

- 0.8W (Con batería) - 3.3 W Max. (Conectado a la corriente).

- Batería Li-ion 3000 mA 4.2V / 12 h autonomía / Carga 4h - 500 ciclos

- Cargador USB 5v DC 1A / IN: 100-240V AC / 50-60Hz

- Ta: 40°C

- IEE: Clase A+ / IP54 / CE

RGBW Led DMX/Lámparas De Mesa

- 5 LEDs Colors. (Azul / Fucsia / Ámbar / Turquesa / Blanco cálido 2700kº)

- ON/OFF y Control de intensidad táctil

- Decodificador DMX 1024 / Señal sin cables 2.4 Ghz

- Controlador Home WIFI DMX Sin Cables, compatible con IOS y Android (no incluido)

- Controlador Profesional DMX Sin Cables, conector XLR (no incluido)

- 0.8W (Con batería) - 3.3 W Max. (Conectado a la corriente).

- Batería Li-ion 3000 mA 4.2V / 12 h autonomía / Carga 4h - 500 ciclos

- Cargador USB 5v DC 1A / IN: 100-240V AC / 50-60Hz

- Ta: 40°C

- IEE: Clase A+ / IP54 / CE



ES | Información Técnica

Materiales /Características

Polipropileno

- Material: Resina de polipropileno con fibra de vidrio, Estabilizador UV.
- Proceso: moldeo por inyección.
- Resistente a los golpes.
- Ligero .
- 100% reciclable.

Poliétileno

- Material: Resina de . Poliétileno lineal de baja densidad. UL94 HB.
- Proceso: Moldeo rotacional.
- Resistente a UV. Factor UV8, equivalente a 8.000 horas de sol de Florida.
- Resistente a temperaturas extremas (-60°C a +80°C) / (-76°F to 176°F)
- Resistente a impactos.
- Ligera.
- Reciclable 100%.

Policarbonato

- Material: Resina de policarbonato. Alta resistencia a la rotura.
- Proceso: moldeo por inyección.
- Resistente a los golpes.
- Ligero .
- 100% reciclable.

Aluminio (pies de mesa)

- Material: AISI12 (EN ACE-44100)
- Proceso: Fundición de aluminio.
- Resistente a los golpes.
- 100% reciclable.
- Pintado al horno con pintura epoxy.

Aluminio (perfilería)

- Material: 6060 (AlMgSi.3.3206,A96060).
- Proceso: Extrusión de aluminio.
- Resistente a los golpes.
- 100% reciclable.
- Pintado al horno con pintura epoxy.

Madera de Teca

- La teca indonesia premium es duradera y excepcionalmente resistente a los elementos
- La teca natural se desgasta hasta adquirir una pátina gris plateada suave con el tiempo debido a los efectos del sol y la humedad

Por favor consulte en la web el mantenimiento y cuidados de la teca

Madera de Teca Envejecida

- La teca indonesia premium es duradera y excepcionalmente resistente a los elementos
- El acabado con cepillo de alambre aplicado a mano de la teca envejecida ofrece un aspecto ya desgastado.

Por favor, consulte en la web el mantenimiento y cuidados de la teca

Relleno de los Cojines para Sillas

Espuma de poliuretano ideal para usos exteriores y en zonas con mucha humedad.

Características Técnicas	Unidad	Valor	Tolerancia
Composición	-	100% Poliéster	-
Tipo de fibra	-	Sólida, semi-dull	-
Tª máxima de utilización	ºC	110.0	± 1.0
Proceso de Fabricación	Cardado por vía seca y consolidado térmico.		
Reciclabilidad	100%, en cuanto a que no contiene aditivos ni ligantes.		

Otras Propiedades:

- No absorbe ni retiene humedad, no es putrescible.
- No constituye alimento para insectos ni roedores.
- No desprende partículas durante su manipulación. Es un producto inocuo, no irrita mucosas ni la piel.

Espuma de Poliuretano (productos tapizados)

Mobiliario fabricado en poliuretano flexible inyectado en frío. Este material posee una alta resiliencia y durabilidad. La espuma flexible de poliuretano posee una estructura celular abierta, es un material muy elástico, que cuando se retira la carga a la que haya sido sometida, recupera instantáneamente su forma original. Dificulta el crecimiento de hongos y bacterias.

- Resistencia a la tracción entre 3 y 10 (Kp/cm2)
- Resistencia a la compresión entre 1,5 y 9 (Kp/cm2)
- Resistencia al cizallamiento entre 1 y 5 (Kp/cm2)
- Módulo de elasticidad entre 40 y 200 (Kp/cm2)

Sobres de mesa /Características

DEKTON®

Superficies cerámicas de alta resistencia, apto para uso interior y exterior.

				Kelya	Entzo	Danae
Resistencia a la flexión y carga de rotura.	UNE EN ISO 10545-4	Resistencia flexión media	N/mm2	46	45	55
		Carga de rotura media	N	2548	2313	2356
		Fuerza de rotura media	N	14966	13559	13818
Absorción de agua, porosidad abierta y densidades.	UNE EN ISO 10545-3	Absorción de agua por ebullición	%	0	0,1	0,1
		Absorción de agua por vacío	%	0,1	0,1	0,1
		Porosidad abierta	%	0,2	0,2	0,2
		Densidad relativa aparente	g/cm3	2,51	2,61	2,53
		Densidad aparente	g/cm3	2,50	2,61	2,52
Abrasión profunda.	UNE EN ISO 10545-6	Volumen abrasionado	mm3	125	106	115
Resistencia al impacto.	UNE EN ISO 10545-5	Coefficiente de restitución medio	-	0,85	0,85	0,85
Dilatación térmica lineal.	UNE EN ISO 10545-8	Dilatación entre 30-100ºC	ºC-1	6,5 · 10-6	5,1 · 10-6	6,3 · 10-6
Resistencia a choque térmico.	UNE EN ISO 10545-9	Daño	-	Pasa sin daño	Pasa sin daño	Pasa sin daño
Dilatación por humedad.	UNE EN ISO 10545-10	Expansión máxima	mm/m	0,1	0,1	0,1
		Expansión media	mm/m	0,0	0,0	0,0
Resitencia a la helada.	UNE EN ISO 10545-12	Daño	-	Pasa sin daño	Pasa sin daño	Pasa sin daño

HPL / Solid Core

Tableros prensado a alta presión y alta temperatura.









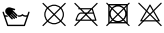

Grosor	ISO 4586 ½	mm	13 ± 0,55		
Densidad	ISO 1183	Kg/m3	1400 - 1500		
Absorción de agua	ISO 4586 ½	%	Peso	2,0 max.	
			Espesor	2,0 max.	
Estabilidad dimensional a altas temperaturas	ISO 4586 ½	%	Long.	0,25 max.	
			Trans.	0,55 max.	
Dureza	ASTM D 785	HR E	97 ca		
Resistencia a la flexión	ISO 178	MPa	MPa	145 min	
			MPa	135 min	

Vidrio

Cristal templado de seguridad. Grosor: 10 mm.

Resistencia al impacto de cuerpo blando			2(B)2
Resistencia contra cambios repentinos de temperatura y diferenciales de temperatura		K	40
Resistencia al viento, nieve, carga permanente e impuesta		mm	10
Atenuación acústica al ruido aéreo directo		dB	34 (-1,-3)
Transmisión térmica (valor U)		W/(m2,K)	5.6
Transmisión luminosa tV			0.53
Reflexión luminosa pV			0.06/0.06
Transmisión energía solar tE			0.52
Reflexión energía solar pE			0.06/0.06

Fabrics /Features

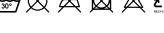
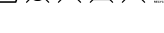
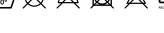
Fabric Tejido	Weight Peso	Flame Resistance Resist. Ignifuga	Resistance Abrasion	Color Fastness Solidez Del Color	Composition Composición	Maintenance Mantenimiento	Symbols Símbolos
Nautical. Suave tela acrílica para exteriores con textura similar al cuero..	657 gr/m2	EN 1021 1-2 DIN 4102 B2 BS 5852 DIN 53438/T2 CAL TB 117	>100.000 ciclos	XENOTEST DIN 54004/ NTC 1479 ASTM D-4329/ CFFA-2 c2	revestimiento de vinilo, 100% Poliester Backing	Limpiar usando un trapo de algodón con jabon neutro diluido en 1/8 partes de agua. Seque con un paño limpio y deje secar.	
Silvertex. Tela de exterior acrílica suave y brillante.	685 gr/m2	EN 1021 1-2 DIN 4102 B2 NF P 92-503 / M2 UNE 23.727-90 IR/ M2 IMO MSC.307 CAL TB 117	>300.000 ciclos	>7 - DIN 54004 NTC 1479 (UV outdoor) 4 - ISO 105B04	revestimiento de vinilo, 100% Poliester Backing	Limpiar con un paño de algodón con solución de jabón neutro 1/9 de agua. Secar con un paño limpio y dejar secar	
Savane. Un tejido irregular revela su belleza textural. Se adapta naturalmente a todos los muebles de exterior.	400 gr/m2	CAL TB 117 NFPA 260 UFAC - Class I	50.000 ciclos	(UV indoor) 8/8 - ISO 105B02 (UV outdoor) 4-5 - ISO 105B04	100% Acrílico	Limpiar con un paño de algodón con 1/5 de solución de lejía doméstica. Retire todos los residuos de lejía con agua. Seque con un paño limpio y deje secar.	 
Dralon. Fibra acrílica básica para exterior para cojines de productos contract.	185 gr/m2	BS5852 0/1 UNE 1021 1 BS7176 Low hazard	25.000 ciclos	(UV indoor) 6-7/8 - ISO 105B02 (water) 5 - ISO 105E03/02/01	100% Acrílico	Limpiar con un paño de algodón con solución jabonosa neutra. Seque con un paño limpio y deje secar.	
Crevin. Tela de tapicería de tamaño medio y trama elegante. 40% fabricado con PET reciclado.	520 gr/m2	EN 1021 1 BS5852 0/1 CAL TB 117 NFPA 260	60.000 ciclos	(water) 4-5 - ISO 105E03/02/01 (UV outdoor) >6 - ISO 105B04	40% Reciclado PET 60% PP	Limpiar con un paño de algodón con 1/5 de solución de lejía doméstica. Retire todos los residuos de lejía con agua. Seque con un paño limpio y deje secar.	
Heritage. Fabricado con un 50% de plásticos reciclados.	335 gr/m2	BS5852 0/1 UNE 1021 1 BS7176 Low hazard	25.000 ciclos	(UV indoor) 7-8/8 - ISO 105B02 (UV outdoor) 5/5 - ISO 105B04	50 % acrílico reciclado, 47 % acrílico Sunbrella, 3 % PE	Limpiar con un paño de algodón con solución jabonosa neutra. Seque con un paño limpio y deje secar.	
Velum. Tejidos ligeros y semitransparentes para cortinas..	165 gr/m2	-	-	(UV indoor) 8/8 - ISO 105E03/02/01 (UV outdoor) 4-5 - ISO 105B04	100% Acrílico	Limpiar con un paño de algodón con 1/5 de solución de lejía doméstica. Retire todos los residuos de lejía con agua. Frote y deje secar.	 
Batyline. Malla acrílica transpirable utilizada en tumbonas y techos solares.	500 gr/m2	EN 1021 1-2 EN 13501 - 1 DIN 4102 B1 NFP 92-507 CAL TB 117 IMO MSC 307	>120.000 ciclos	4/5 ASTM G154	Fibra de poliéster protegida con revestimiento de PVC.	Lave la malla con un detergente líquido suave y agua dulce, utilizando un cepillo de cerdas suaves. La malla Batylíne tiene tratamiento anti hongos donde la humedad no le afectará.	
Cico. Tejido acogedor de aspecto elegante y tacto suave.	423 gr/m2	BS5852 0/1	25.000 ciclos	(UV indoor) 7/8 - ISO 105B02 (UV outdoor) 4/5 - ISO 105B04	100% polipropileno	Limpiar con un paño de algodón con solución jabonosa neutra. Seque con un paño limpio y deje secar.	
Siesta. Tejido acogedor de aspecto elegante y tacto suave.	500 gr/m2	TB117-2013 UNE 1021 1	60.000 ciclos	-	100% polipropileno	Limpiar con un paño de algodón con solución jabonosa neutra. Seque con un paño limpio y deje secar.	
Acapulco. Tejido acogedor de aspecto elegante y tacto suave.	500 gr/m2	TB117-2013 UNE 1021 1	>30.000 ciclos	-	100% polipropileno	Limpiar con un paño de algodón con solución jabonosa neutra. Seque con un paño limpio y deje secar.	
Ikon 36. Tejido acogedor de aspecto elegante y tacto suave	650 gr/m2	TB117-2013 UNE 1021 1	30.000 ciclos	-	100% polipropileno	Limpiar con un paño de algodón con solución jabonosa neutra. Seque con un paño limpio y deje secar.	
Krollet. Elegant fabric with a pleasant touch and great comfort.	985 gr/ml	-	40.000 cycles	-	94% PP + 6 % PC S.D.		
Varm. Tejido acogedor de tacto agradable y gran comodidad.	850 gr/m2	cigarette test: BS5852 part 1:(1990)	60.000 cycles	Factor 7UV UNI EN ISO 20105-B02	100% polipropileno		
Hygge. Tejido acogedor de tacto agradable y gran comodidad.	910 gr/m2	cigarette test: BS5852 part 1:(1990)	60.000 cycles	Factor 7UV UNI EN ISO 20105-B02	100% polipropileno		
Glad. Tejido premium con una amplia gama de colores.	975 gr/m2	cigarette test: BS5852 part 1:(1990)	30.000 cycles	Factor 7UV UNI EN ISO 20105-B02	100% polipropileno	El detergente en polvo no debe contener agentes oxidantes ni abrillantadores. En caso de que caiga líquido o agua sobre la tela, elimine todos los derrames inmediatamente, pero no frote el tejido. Seque suavemente los derrames de líquidos con un paño limpio y seco.	

ES | Información Técnica

DMX Sin cables

DMX 512 (Digital MultipleX), es un protocolo electrónico utilizado en luminotecnía para el control de la iluminación de espectáculos, permitiendo la comunicación entre los equipos de control de luces y las propias fuentes de luz. DMX Sin Cables. Puedes crear ambientes especiales y personalizados. Permite controlar cada producto Vondom de manera independiente o en grupos.

Hay 2 tipos de DMX Wireless, dependiendo las necesidades del cliente.

DMX Wireless Professional XLR Pack

Con Vondom DMX Profesional XLR Sin cables se puede controlar todos los productos VONDOM mediante una mesa de mezclas, Ordenadores + Programa, Paneles Domóticos, etc.

- 1* DMX Wireless Configuración Estándar
Están preconfiguradas tres Familias independientes: MACETAS, LAMPARAS, MOBILIARIO.
- 2* DMX Wireless Configuración Personalizada
Puede indicarnos los productos o grupos que necesita controlar independientemente y nosotros lo configuraremos.

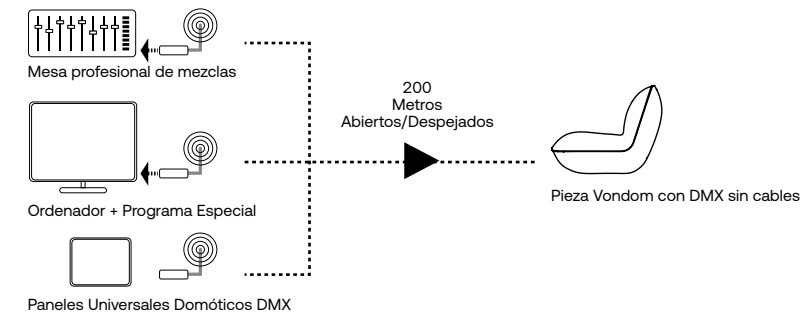

2* Ejemplo de configuración personalizada DMX Wireless Professional

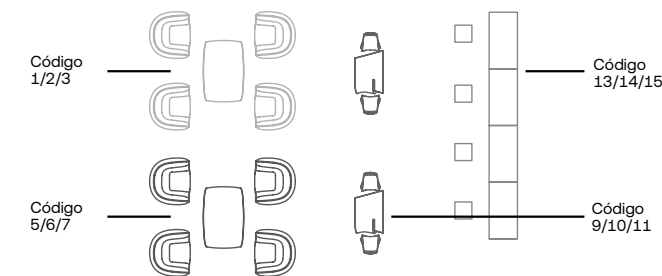

DMX IS FUN!

DMX Wireless Home Wifi Pack

El paquete Home Wi-Fi Vondom DMX Sin cables es un punto de acceso WI-FI con el que controlar todos sus productos VONDOM mediante sus dispositivos IOS o Android.

- 1* DMX Wireless Configuración Estándar
Están preconfiguradas tres Familias independientes: MACETAS, LAMPARAS, MOBILIARIO.
- 2* DMX Wireless Configuración Personalizada
Puede indicarnos los productos o grupos que necesita controlar independientemente y nosotros lo configuraremos. (Máx. 8 zonas)

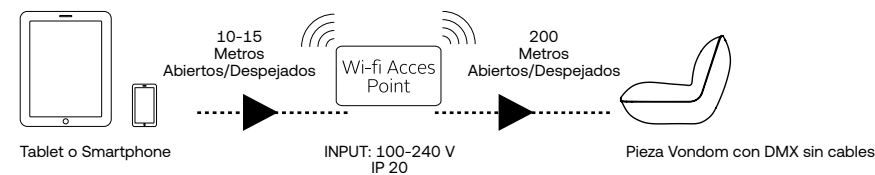

2* Ejemplo de configuración personalizada DMX Wireless Home

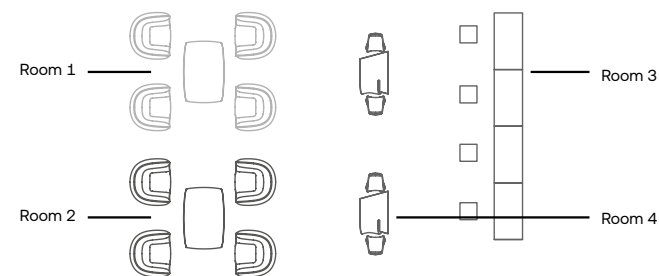

Mantenimiento y Seguridad / General

Nuestra producción se rige según las normas de nuestro sistema de aseguramiento de la calidad ISO 9001:2008 y de medio ambiente ISO 14001:2004. Y solamente utilizamos materiales de altísima calidad para garantizar una larga vida útil a los productos.

Para proporcionarle un uso duradero y seguro al producto, por favor siga las siguientes instrucciones:

- La exposición continua al Sol, especialmente los colores oscuros, puede provocar lesiones por contacto con la piel. Tenga la precaución de verificar la temperatura de los muebles antes de su uso en horas de sol extremo.
- Coloque la pieza en una superficie regular y sin pendiente para evitar desplazamientos incontrolados.
- Manténgala alejada de fuentes de calor excesivas.
- El producto no es un juguete. No permita que los niños jueguen con ellos, para evitar accidentes.
- Mantenga sus muebles fuera de fuentes de polvo para mantenerlos limpios. En caso de que se requiera su limpieza se recomienda el uso de sistemas de presión de agua tipo KARCHER y/o desengrasantes domésticos de forma periódica. Nunca utilice productos abrasivos o corrosivos.
- Para una mejor conservación del mobiliario, se aconseja cubrir con fundas para cada uno de los artículos.
- En los productos lacados hay que extremar su cuidado puesto que son más delicadas, no debe utilizar agua a presión ni productos abrasivos o corrosivos. Para ello, es aconsejable aplicar cada 2 ó 3 meses cera de carrocería y así eliminar la aparición de posibles arañazos.
- Existen acolchados aptos para el exterior, disponibles para algunas colecciones. Se recomienda limpiarlos periódicamente utilizando un paño con jabón neutro y agua.
- Limpie las partes de acero inoxidable con productos adecuados.
- En caso de sustituir la bombilla, asegúrese de que el cable no está conectado a la corriente eléctrica.
- Si el cable sufre algún deterioro, debe cambiarse exclusivamente por el fabricante o por un profesional.
- Si el LED dejara de funcionar, no manipular en ningún caso y contactar con el fabricante o distribuidor del producto.

Limpieza / General

Vondom Mobiliario de exterior se limpia fácilmente y permanece impecable.

Pasos para limpiar mobiliario the exterior:

1. Pulverice con un quitagrasas la superficie a limpiar.
 2. Frote con un paño húmedo y agua.
 3. Aclare con abundante agua con un sistema de agua a presión.
 4. Déjalo secar en el exterior.
- ¡Atención! No use el sistema de agua a presión para acolchados y acabados lacados.

Esperemos que disfrute de nuestros productos. Si desea más información no dude en comunicárselo a nuestro departamento de ATENCIÓN AL CLIENTE llamando al **+34 96 239 84 86** o enviando un correo electrónico a **info@vondom.com**

Leyendas

- Evitar la exposición directa al sol y la lluvia.

Design VCD_0423
Vondom Octubre_2023

ES | Las posibles diferencias entre el color original y el color reproducido se deben a la técnica de impresión.

VONDOM se reserva el derecho exclusivo sobre todas las marcas, fotografías y diseños utilizados en sus colecciones, por lo que queda prohibida la fabricación, distribución y/o comercialización de los productos que los contienen, en cualquier medio o soporte.

En particular quedan reservados a favor de su titular los derechos de reproducción total o parcial, la transformación de los mismos y/o su utilización fuera de la esfera privada y con fines comerciales.

VONDOM se reserva el derecho de modificar total o parcialmente sin aviso previo cualquiera de los datos y especificaciones de esta publicación.

Toda la información que aparece en este catálogo referente a dimensiones y capacidades son aproximadas.

© Copyright. 2023. Vondom, S.L.U.

Todos los Derechos a beneficio de VONDOM

EN | The possible differences between pictures and real items could be due to the colors in the printing technology process.

VONDOM all rights related to trademarks, pictures and designs are reserved.

All manufacturing distribution and/or trading activities in any media of the products displayed in the collections are prohibited. Specifically those rights about total or partial reproduction, transformation and/or usage in public with commercial purposes.

VONDOM reserves the right to effect any changes or improvements, without notice.

All the information included in this catalogue regarding sizes and capacities are approximated.

© Copyright. 2023. Vondom, S.L.U.

All rights reserved to the order of VONDOM



Control Remoto / Instrucciones

- Repetir la última orden (Enviar la orden de nuevo)
- on / off
- A/B/C Grupos (A = Mobiliario / B = Macetas / C = Lámparas) Se pueden personalizar, máximo 3.
- ABC Controlar todas los grupos a la vez
- Cambio de color automático
- Botón Memoria (para programar un color personalizado) (consultar las funciones avanzadas)
- Colores programados
- Blanco cálido 2700K / Blanco natural 4000k / Blanco frío 6500k
- +/- Mas o menos (velocidad o intensidad)

- Pilas para el Control Remoto: CR2032
- Controlador RF 433 Mhz / 10-15 metros de alcance.
- IP20 / Apto solo para uso interior.

VONDOM

vondom.com

Head Quarters / Factory

VONDOM S.L.U.
Poligono 6, 16
46293 - Beneixida, Valencia - Spain
t.: +34 96 239 84 86 • info@vondom.com

Latinoamérica

Av. Pdte. Masaryk 42, Rincón del Bosque,
Polanco V Secc, Miguel Hidalgo
11580 Ciudad de México, México
t.: +52 55 11 13 99 73 • +52 55 11 99 74
latam@vondom.com

USA

VONDOM LLC.
8803 NW 23rd Street,
Miami, FL 33172 - USA
ph.: +1 786 391 0274 • +1 786 353 9108
infousa@vondom.com

China

VONDOM Lifestyle Design Co., Ltd.
C6-103, No. 700, Wan Rong Road, Jing An
200072 - Shanghai - China
+86 21 6521 9916
infochina@vondom.com



VONDOM