

BOLD 85

BOLD 58

“Ho pensato a Bold58 come un insieme coerente in termini di sensazioni, di colori e di funzionalità. La leggerezza data da una visione dinamica della sospensione contrapposta alla rassicurante stabilità degli elementi scultorei, sono alla base del design di questa collezione. Un segno nuovo e deciso nell'ambiente ufficio.”

- design Roberto Giacomucci -

“I thought about Bold58 as a coherent whole in terms of sensations, colors and functionality. The lightness given by a dynamic view of the suspension contrasted with the reassuring stability of the sculptural elements, are the basis of the design of this collection. A new and determinate sign in the office environment.”

- design Roberto Giacomucci -

“J'ai pensé à Bold58 comme un ensemble cohérent en termes de sensations, de couleurs et de fonctionnalités. La légèreté donnée par une vision dynamique de la suspension par opposition à la stabilité rassurante des éléments sculpturaux, sont à la base du design de cette collection. Un signe nouveau et décidé dans l'environnement de bureau.”

- design Roberto Giacomucci -



Design e comfort si fondono insieme per un ambiente di lavoro piacevole e intrigante che non vuole rinunciare all'eleganza delle forme e dei colori. È questo lo spirito della collezione BOLD58, una collezione di prestigio pensata per spazi contemporanei e raffinati.

Gli elementi di arredo raccontano una funzionalità e una creatività tutta da vivere: giochi di volumi dinamici e mai convenzionali si coniugano alla cura del dettaglio e alla praticità, per immergersi in un'atmosfera fine ed accogliente. Il piano di lavoro della scrivania, dallo spessore importante, è l'elemento focale dell'arredo, attorno al quale si sviluppano armonicamente tutti gli altri elementi, in un intreccio razionale di volumi orizzontali e verticali e di combinazioni di pieni e vuoti: le cassettiere, i mobili di servizio, le estensioni del piano vanno a incorniciare una postazione ogni volta nuova. L'effetto sospeso del piano, grazie al supporto in vetro, conferisce leggerezza e grazia all'elemento scrivania, abbinato a finiture in essenza, tinta unita e al metallo.

Design and comfort come together for a pleasant and intriguing work environment that does not want to give up the elegance of shapes and colors. This is the spirit of the BOLD58 collection, a prestigious collection designed for contemporary and refined spaces. The furnishing elements tell of functionality and creativity to be experienced: dynamic and never conventional plays of volumes are combined with attention to detail and practicality, to host yourself in a refined and welcoming atmosphere. The worktop of the desk, with an important thickness, is the focal element of the furniture, around which all the other elements develop harmoniously, in a rational intertwining of horizontal and vertical volumes and combinations of full and empty: the drawer units, the service furniture, the top extensions frame a new workstation every time. The suspended effect of the top, thanks to the glass support, gives lightness and grace to the desk element, combined with wood, solid color and metal finishes.

Design et confort se combinent pour un environnement de travail agréable et intrigant qui ne veut pas renoncer à l'élégance des formes et des couleurs. C'est l'esprit de la collection BOLD58, une collection de prestige conçue pour des espaces contemporains et raffinés. Les éléments d'ameublement racontent une fonctionnalité et une créativité toute à vivre : des jeux de volumes dynamiques et jamais conventionnels se conjuguent au soin du détail et à la praticité, pour se plonger dans une atmosphère fine et accueillante. Le plan de travail du bureau, avec un épaisseur importante, est l'élément focal du mobilier, autour duquel se développent harmonieusement tous les autres éléments, dans un entrelacement rationnel de volumes horizontaux et verticaux et de combinaisons de pleins et de vides : les caissons, les meubles de service, les extensions du plateau vont encadrer un poste à chaque fois neuf. L'effet suspendu du plateau, grâce au support en verre, confère légèreté et grâce à l'élément de bureau, combiné à des finitions en essence, teinte unie et au métal.

LEAVEN

Solido e fluttuante.

La scrivania LEAVEN si combina al mobile di servizio racchiudendolo con raffinatezza nella gonna, in un gioco di volumi a sviluppo orizzontale. Il componente in vetro trasparente divide e al tempo stesso congiunge i due elementi d'arredo.

Solid and floating.

The LEAVEN desk is combined with the service cabinet, enclosing it with refinement in the modesty panel, in a play of horizontal volumes. The transparent glass component divides and at the same time joins the two pieces of furniture.

Solide et flottant.

Le bureau LEAVEN se combine au meuble de service en le renfermant avec raffinement dans la voile de fond, dans un jeu de volumes à développement horizontal. Le composant en verre transparent sépare et relie en même temps les deux éléments d'ameublement.







Il tavolo riunioni, con struttura in metallo TITANIO, è composto da una base e quattro colonne in metallo, a supporto del piano NOCE BOHEME, spessore 58 mm.

The meeting table, with TITANIUM metal structure, is composed of a base and four metal columns, supporting the WALNUT BOHEME top, 58 mm thick.

La table de réunion, avec structure en métal TITANE, est composée d'une base et de quatre colonnes en métal, au support du plateau NOYER BOHEME, épaisseur 58 mm.



Il mobile di servizio, integrato alla scrivania, è composto da struttura e ante scorrevoli NOCE BOHEME, cassetti centrali NERI con sistema di apertura PUSH&PULL. La base rientrata che lo sorregge crea un effetto di sospensione.

The service cabinet, integrated into the desk, is composed of a WALNUT BOHEME structure and sliding doors, BLACK central drawers with PUSH & PULL opening system. The supporting recessed base creates a suspension effect.

Le meuble de service, intégré au bureau, est composé par la structure et les portes coulissantes NOYER BOHEME, tiroirs centraux NOIRS avec système d'ouverture PUSH&PULL. La base rentrée qui le soutient crée un effet de suspension.



La nuova madia BOLD58 è formata da una base in metallo color TITANIO, elementi con posizione sfalsata ad anta battente in vetro FUMÉ e telaio in alluminio NERO. La composizione si completa attraverso una struttura perimetrale laccata VERDE OLIVA con lavorazione a 45°.

The new BOLD58 sideboard is made up of a TITANIUM-colored metal base, elements with staggered position with SMOKED glass hinged door and BLACK aluminum frame. The composition is completed by means of an OLIVE GREEN lacquered perimeter structure with 45° junction.

Le nouveau buffet BOLD58 est formé par une base en métal couleur TITANE, éléments avec position décalée avec porte battante en verre FUMÉ et cadre en aluminium NOIR. La composition se complète à travers une structure périmétrique laquée VERT OLIVE avec usinage à 45°.

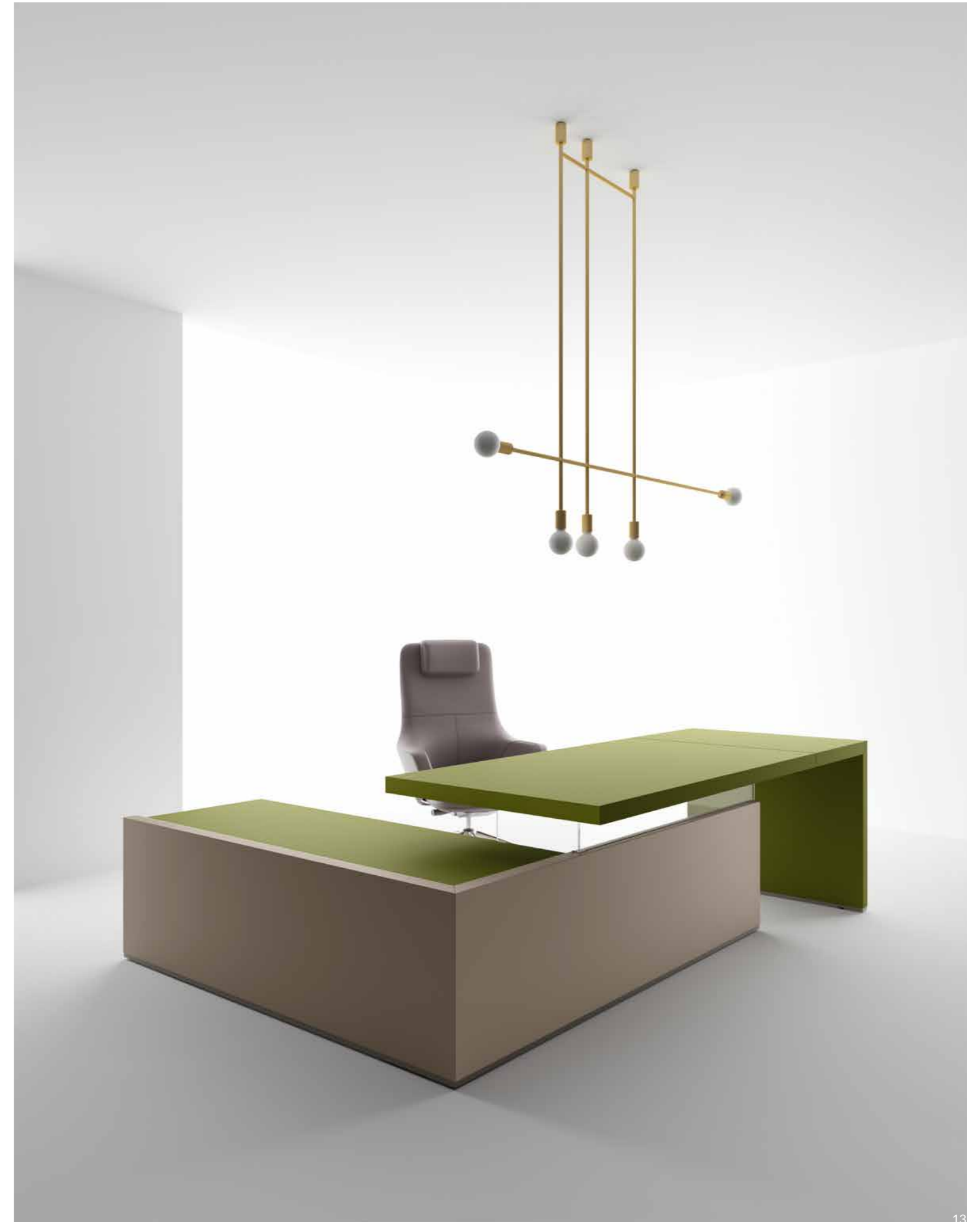



FUSION

Intramontabile e inedito.

La scrivania FUSION con cassettera è un'icona senza tempo di stile e ricercatezza. Gli effetti a incastro e le illusioni sospese creano accostamenti dinamici tra gli elementi: la cassettera, estensione funzionale per il contenimento, è racchiusa nella gonna, e crea continuità con il piano scrivania, in appoggio sul supporto in vetro.

Timeless and unprecedented.

The FUSION desk with drawers is a timeless icon of style and refinement. The interlocking effects and the suspended illusions create dynamic combinations between the elements: the drawer pedestal, a functional extension for storage, is enclosed in the modesty panel, and creates continuity with the desk top, resting on the glass support.

Intemporel et inédit.

Le bureau FUSION avec caisson est une icône intemporelle de style et de raffinement. Les effets d'emboîtement et les illusions suspendues créent des combinaisons dynamiques entre les éléments : le caisson, extension fonctionnelle pour le rangement, est enfermée dans la voile de fond, et crée une continuité avec le plateau de bureau, en appui sur le support en verre.







Il piano, sospeso rispetto alla struttura portante, si realizza attraverso l'inserimento di un elemento in vetro trasparente.

The top, suspended from the supporting structure, is created by inserting a transparent glass element.

Le plateau, suspendu par rapport à la structure portante, est réalisé par l'insertion d'un élément en verre transparent.



La nuova madia si compone di una base in metallo finitura BRONZO ed elementi ad anta battente, incorniciati da una struttura con lavorazione a 45°, in finitura NOCE BOHEME.

The new sideboard consists of a BRONZE finish metal base and hinged door elements, framed in a 45° junction structure, in WALNUT BOHEME finish.

Le nouveau buffet se compose d'une base en métal finition BRONZE et éléments à porte battante, encadrés dans une structure avec usinage à 45°, en finition NOYER BOHEME.

La libreria GATE è caratterizzata da un telaio esterno portante in metallo TITANIO, ripiani e divisori in finitura NERO; è personalizzabile con pensili dalla struttura NERA e ante a battente NOCE BOHEME che vanno ad inserirsi negli spazi a giorno.

The GATE bookcase is characterized by an external supporting frame in TITANIUM metal, shelves and dividers in BLACK finish; it can be customized with wall units with a BLACK structure and WALNUT BOHEME hinged doors that are inserted in the open spaces.

La bibliothèque GATE est caractérisée par un cadre extérieur portant en métal TITANE, étagères et panneaux de séparation en finition NOIR; elle est personnalisable avec des meubles suspendus avec la structure NOIRE et des portes à battantes NOYER BOHEME qui doivent être insérés dans les espaces à jour.



Il tavolo MAGNUM, realizzato con piano da 58 mm in essenza NOCE BOHEME, poggia su una solida struttura con finitura NERA e uno zoccolo TITANIO; si completa con un sistema centrale di elettrificazione.

The MAGNUM table, made with a 58mm top in BOHEME WALNUT essence, rests on a solid BLACK finish structure and a TITANIUM plinth; it is completed with a central electrification system.

La table MAGNUM, réalisée avec plateau de 58 mm en essence NOYER BOHEME, repose sur une solide structure en finition NOIRE et une plinthe TITANE; elle se complète avec un système central d'électrification.







La nuova soluzione di mobile di servizio è composta da una base in metallo TITANIO, una struttura con due ante scorrevoli in EUCALIPTO e due cassetti centrali con sistema di apertura PUSH&PULL in finitura GRIGIO FANGO.

The new service unit solution consists of one TITANIUM metal base, a structure with two sliding doors in EUCALYPTUS and two central drawers with opening system PUSH & PULL in MUD GRAY finish.

La nouvelle solution du mobile de service se compose d'une base en métal TITANE, d'une structure avec deux portes coulissantes en EUCALYPTUS et deux tiroirs centraux avec système d'ouverture PUSH&PULL en finition GRIS BOUE.





DECK

Spazioso e lineare.

La scrivania con allungo laterale crea un piano di lavoro ampio e funzionale, ideale per arredare un ambiente direzionale con classe e spiccato gusto estetico. L'orientamento degli elementi, che si incontrano perpendicolarmente, rende unica questa soluzione grazie a un gioco di volumi impreziosito dalle venature dell'essenza del piano.

Spacious and linear.

The desk with side extension creates a large and functional work surface, ideal for furnishing an executive environment with class and strong aesthetic taste. The orientation of the elements, that meet perpendicularly, makes this solution unique thanks to a play of volumes embellished by the grain of the essence of the worktop.

Spacieux et linéaire.

Le bureau avec l'extension latérale crée un plan de travail large et fonctionnel, idéal pour meubler un environnement directionnel avec classe et marqué goût esthétique. L'orientation des éléments, qui se rencontrent perpendiculairement, rend cette solution unique grâce à un jeu de volumes enrichi par les veinures de l'essence du plateau.





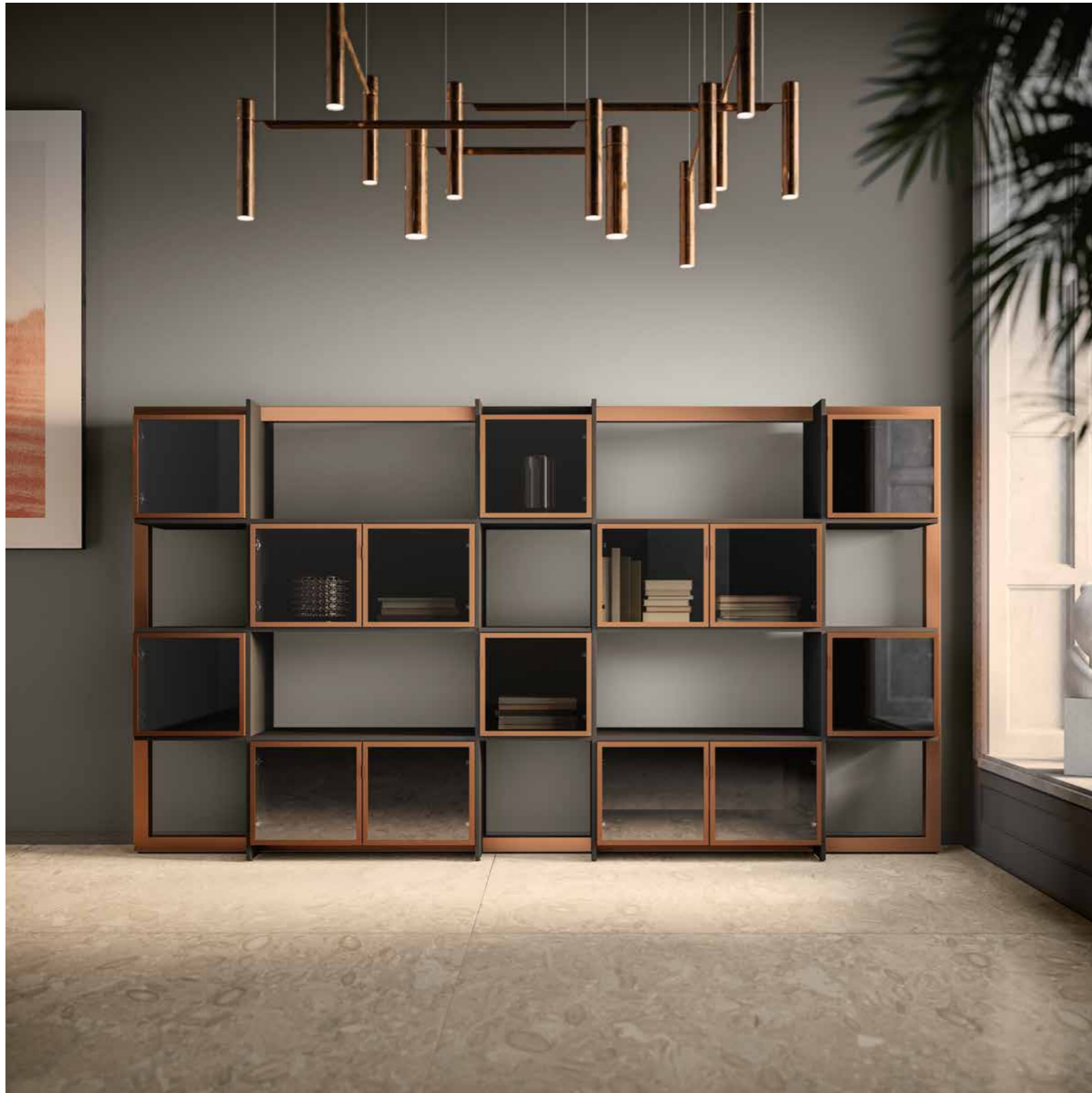

La libreria GATE, con telaio esterno strutturale in metallo color BRONZO e divisori e ripiani in finitura NERO, si completa di elementi ad anta battente in vetro FUMÈ e telaio BRONZO. Opzionale esclusivo l'accessorio luce led con sensore di apertura anta che ne regola accensione e spegnimento.

The GATE bookcase, with a structural external frame in colored metal BRONZE and dividers and shelves in BLACK finish, complete with elements with hinged door in SMOKED glass and BRONZE frame. The LED light accessory with door opening sensor is an exclusive option which regulates the switching on and off.

La bibliothèque GATE, avec cadre extérieur structurel en métal couleur BRONZE et panneaux de séparation et étagères en finition NOIRE, se complète des éléments avec porte battante en verre FUMÈ et cadre BRONZE. Option exclusive l'accessoire lumière led avec capteur d'ouverture de porte qui en règle l'allumage et l'extinction.

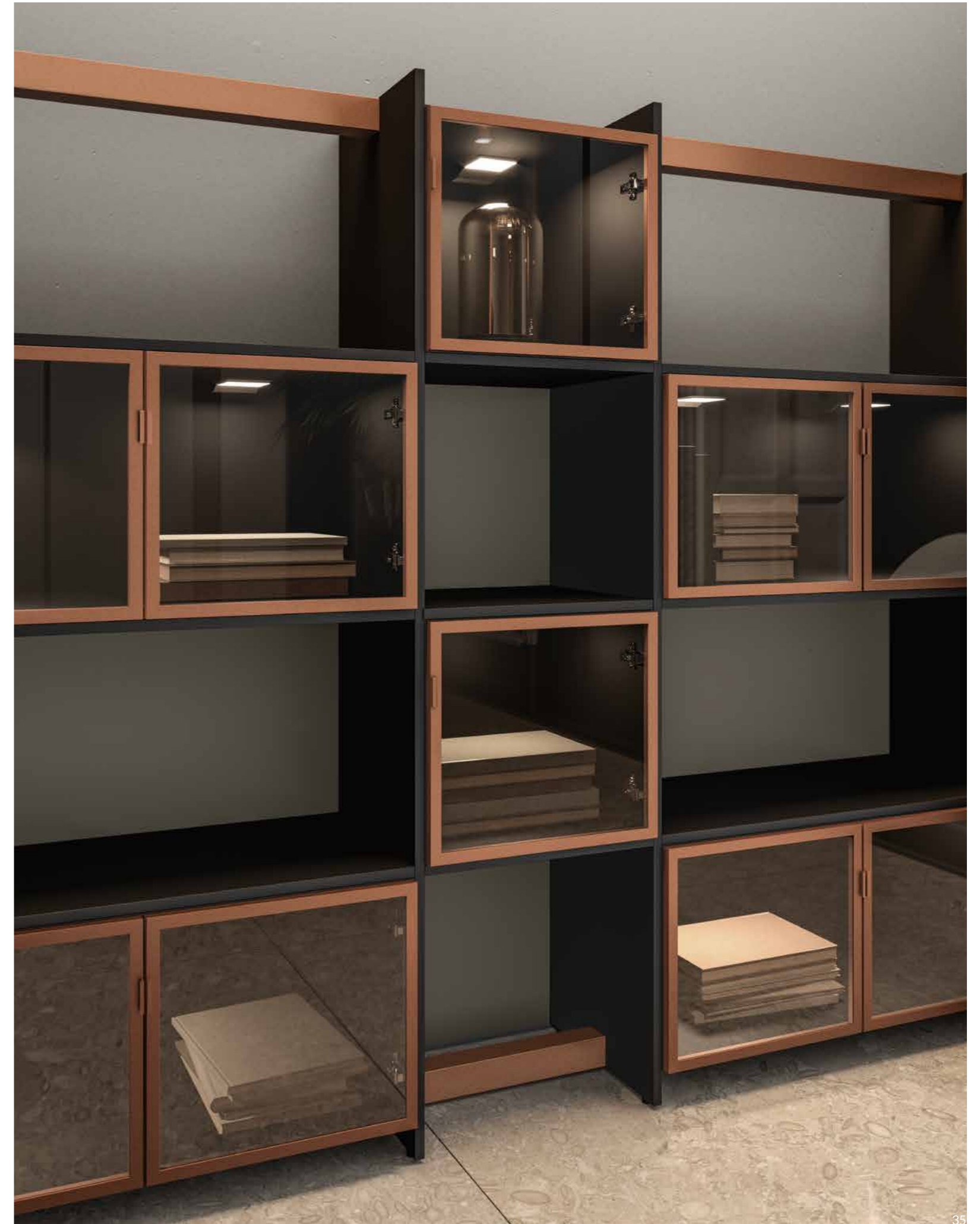



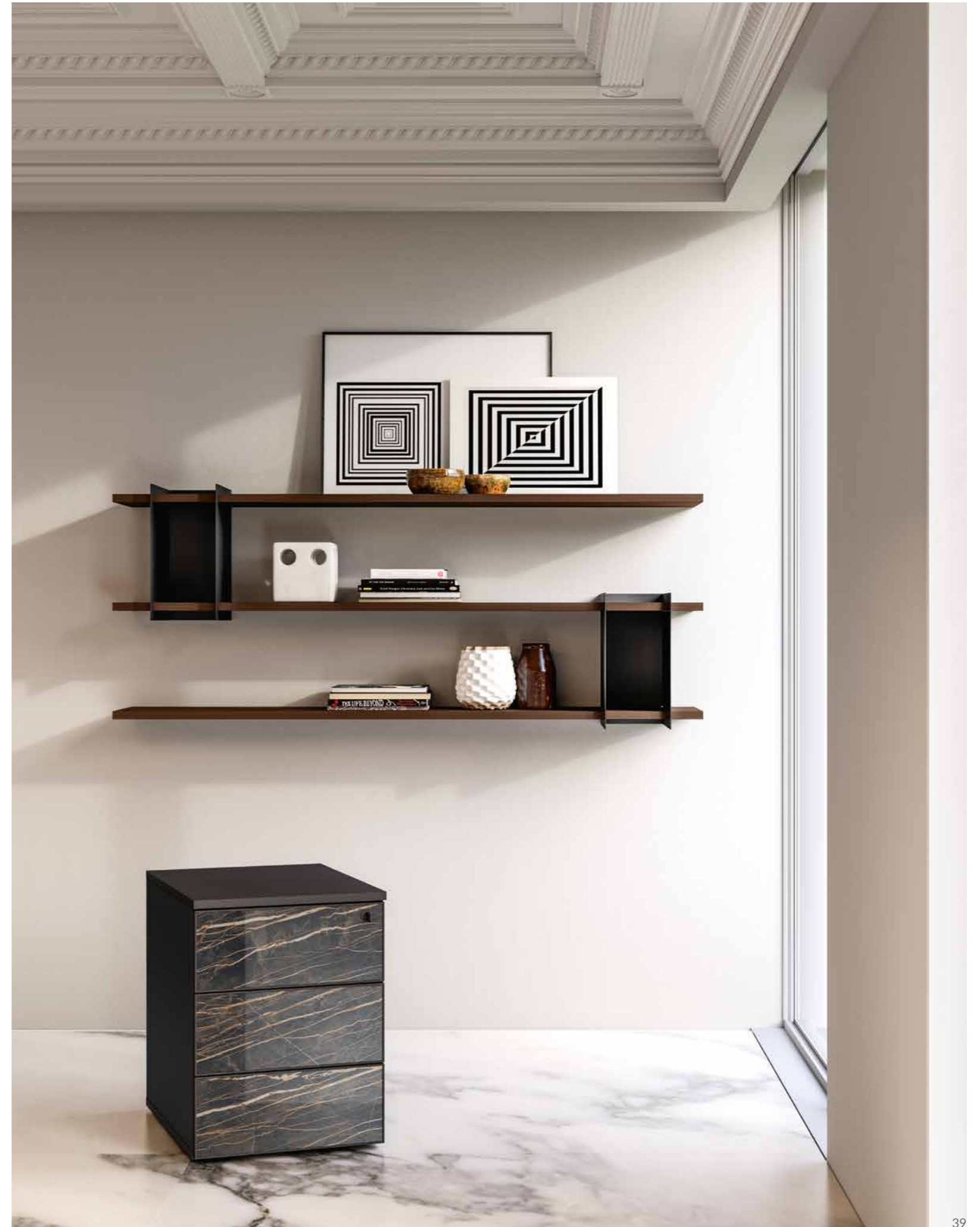

BRIDGE

Semplice e autentico.

La scrivania BRIDGE, con doppio fianco e gonna frontale, ha una struttura a ponte sobria e di carattere, enfatizzata con naturalezza dalla contrapposizione di pesi, volumi e finiture: da un lato la solidità dei materiali naturali, con le venature dell'essenza del piano di lavoro e dei fianchi; dall'altro la leggerezza del vetro.

Simple and authentic.

The BRIDGE desk, with double side and front modesty panel, has a sober bridge structure with character, emphasized naturally from the contrast of weights, volumes and finishes: on the one hand solidity of natural materials, with the grain of the essence of the worktop and side panels; on the other, the lightness of the glass.

Simple et authentique.

Le bureau BRIDGE, avec double panneau latéral et voile de fond frontale, a une structure en pont sobre et de caractère, souligné naturellement par l'opposition des poids, des volumes et des finitions: d'une part la solidité des matériaux naturels, avec les veinures de l'essence du plan de travail et des côtés latéraux; d'autre part, la légèreté du verre.







Soluzione originale per la nuova media: struttura esterna in EUCALIPTO, base in metallo BRONZO, elementi a giorno laccati TITANIO nella parte superiore, anta in vetro trasparente e telaio NERO in quella inferiore; a completamento gli accessori led opzionali.

Original solution for the new sideboard: external structure in EUCALYPTUS, base in BRONZE metal, open elements lacquered TITANIUM in the upper part, door in transparent glass and BLACK frame in the lower part; to complete the optional LED accessories.

Solution originale pour le nouveau buffet : structure extérieure en EUCALYPTUS, base en métal BRONZE, éléments à jour laqués TITANE dans la partie supérieure, porte en verre transparent et cadre NOIR dans la partie inférieure; en complément des accessoires LED en option.









IMPERIAL

Elegante e di pregio.

La scrivania IMPERIAL con la cassettera integrata è una soluzione ricca di personalità. La profondità importante degli elementi, dal piano lavoro alla cassettera, rende imponente e maestoso un ambiente di lavoro dai richiami classici e sofisticati.

Elegant and valuable.

The IMPERIAL desk with integrated pedestal drawer unit is a solution full of personality. The important depth of the elements, from the worktop to the pedestal, makes a work environment with classic and sophisticated references imposing and majestic.

Élégant et de prestige.

Le bureau IMPERIAL avec le caisson intégré est une solution riche en personnalité. La profondeur importante des éléments, du plateau de travail au caisson, rend imposant et majestueux un environnement de travail aux rappels classiques et sophistiqués.







I piani in essenza della collezione BOLD58 sono formati da una combinazione di elementi con orientamento venatura a contrasto. L'estensione del piano di lavoro si collega al fianco laterale tramite una giunzione a 45°.

The wooden tops of the BOLD58 collection are made up of a combination of elements with a contrasting grain orientation. The extension of the worktop connects to the side through a 45° junction.

Les plateaux en essence de la collection BOLD58 sont formés d'une combinaison d'éléments avec orientation veinure à contraste. L'extension du plan de travail est reliée au panneau latéral par une jonction à 45°.



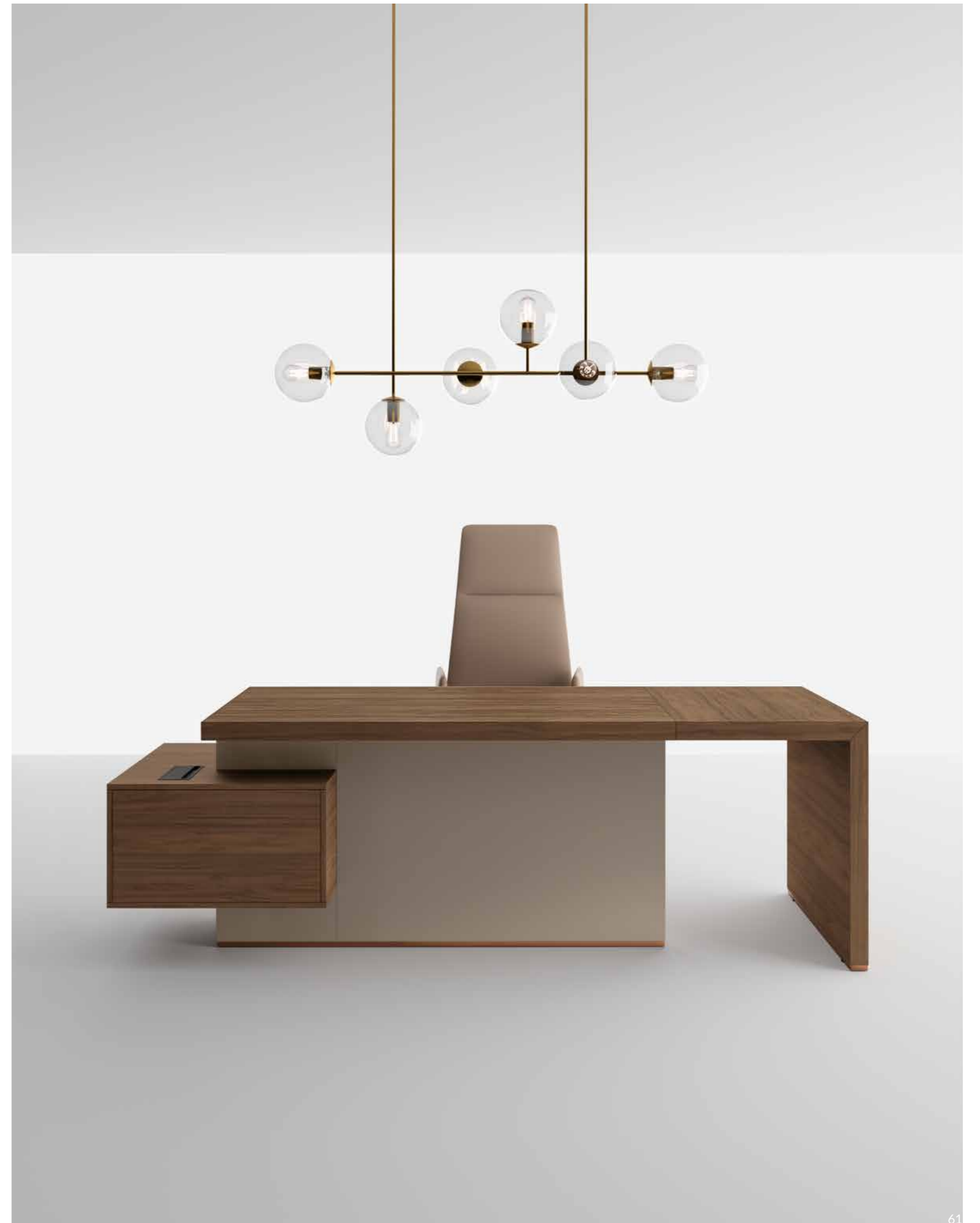

MAGNUM

Imponente e sofisticato.

Il tavolo riunioni, dall'accentuato sviluppo longitudinale, domina l'ambiente con giochi di volumi e di finiture a contrasto. Le basi monolitiche sorreggono con solidità il piano di lavoro, talvolta alleggerito dalla trasparenza del vetro.

Imposing and sophisticated.

The meeting table, with its accentuated longitudinal development, dominates the environment with plays of volumes and contrasting finishes. The basics monolithic elements solidly support the worktop, sometimes lightened by the transparency of the glass.

Majestueux et sophistiqué.

La table de réunion, au développement longitudinal accentué, domine l'environnement avec des jeux de volumes et de finitions contrastées. Les bases monolithiques soutiennent avec solidité le plateau de travail, parfois allégé par la transparence du verre.







Dettaglio di pregio per i mobili contenitore nella versione FRAME: gli elementi di contenimento con ante in vetro trasparente e telaio BRONZO sono incorniciati da un distanziale in finitura TITANIO, sormontato da una composizione innovativa di top e fianchi EUCALIPTO con orientamenti vena contrapposti.

Precious detail for the storage units in the FRAME version: the storage elements with transparent glass doors and BRONZE frame are framed by a spacer in TITANIUM finish, surmounted by an innovative composition of EUCALYPTUS top and sides with opposing vein orientations.

Détail de valeur pour les armoires dans la version FRAME : les éléments de rangement avec portes en verre transparent et cadre BRONZE sont encadrés par une entretoise en finition TITANE, surmonté d'une composition innovante de top et panneaux latéraux de finition EUCALYPTUS avec des orientations de veinure opposées.

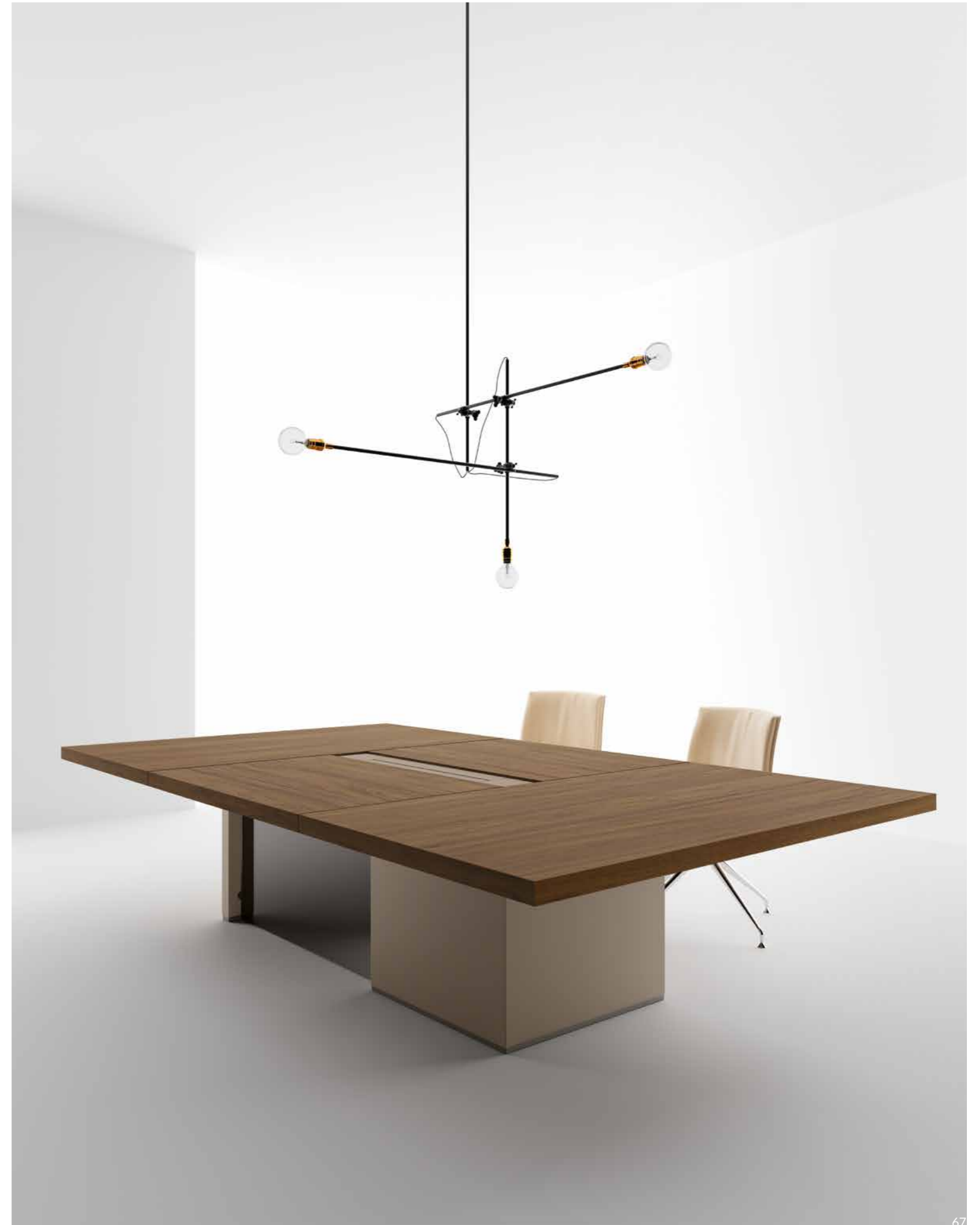





Composizione inedita del mobile di servizio direzionale con ante in vetro FUMÉ e telaio NERO, su una struttura con cassetti in finitura NOCE BOHEME e zoccolo NERO: eleganza e prestigio per un complemento d'arredo indispensabile.

Unpublished composition of the executive service cabinet with SMOKED glass doors and BLACK frame, on a structure with drawers in WALNUT BOHEME finish and BLACK plinth: elegance and prestige for an indispensable piece of furniture.

Composition inédite du meuble de service directionnel avec portes en verre FUMÉ et cadre NOIR, sur une structure avec tiroirs en finition NOYER BOHEME et plinthe NOIRE : élégance et prestige pour un complément d'ameublement indispensable.

UNIVERSE

Funzionale e d'impatto.

La postazione reception è pensata per fondere praticità e fascino senza tempo. I creativi incastri orizzontali e verticali dei blocchi creano un ambiente dinamico e confortevole, in cui i vari elementi si raccontano attraverso le diverse finiture della scrivania e delle mensole, in melaminico, laccato, vetro laccato o Laminam®.

Functional and impactful.

The reception area is designed to blend practicality and timeless charm. The creative horizontal and vertical joints of the blocks create a dynamic and comfortable environment, where the various elements are told through the different finishes of the desk and shelves, in melamine, lacquer, lacquered glass or Laminam®.

Fonctionnel et d'impact.

La banque d'accueil est conçue pour allier praticité et charme intemporel. Les créatifs encastres horizontaux et verticaux des blocs créent un environnement dynamique et confortable, dans lequel les différents éléments se racontent à travers les différentes finitions du bureau et des étagères, en mélaminé, laqué, verre laqué ou Laminam®.



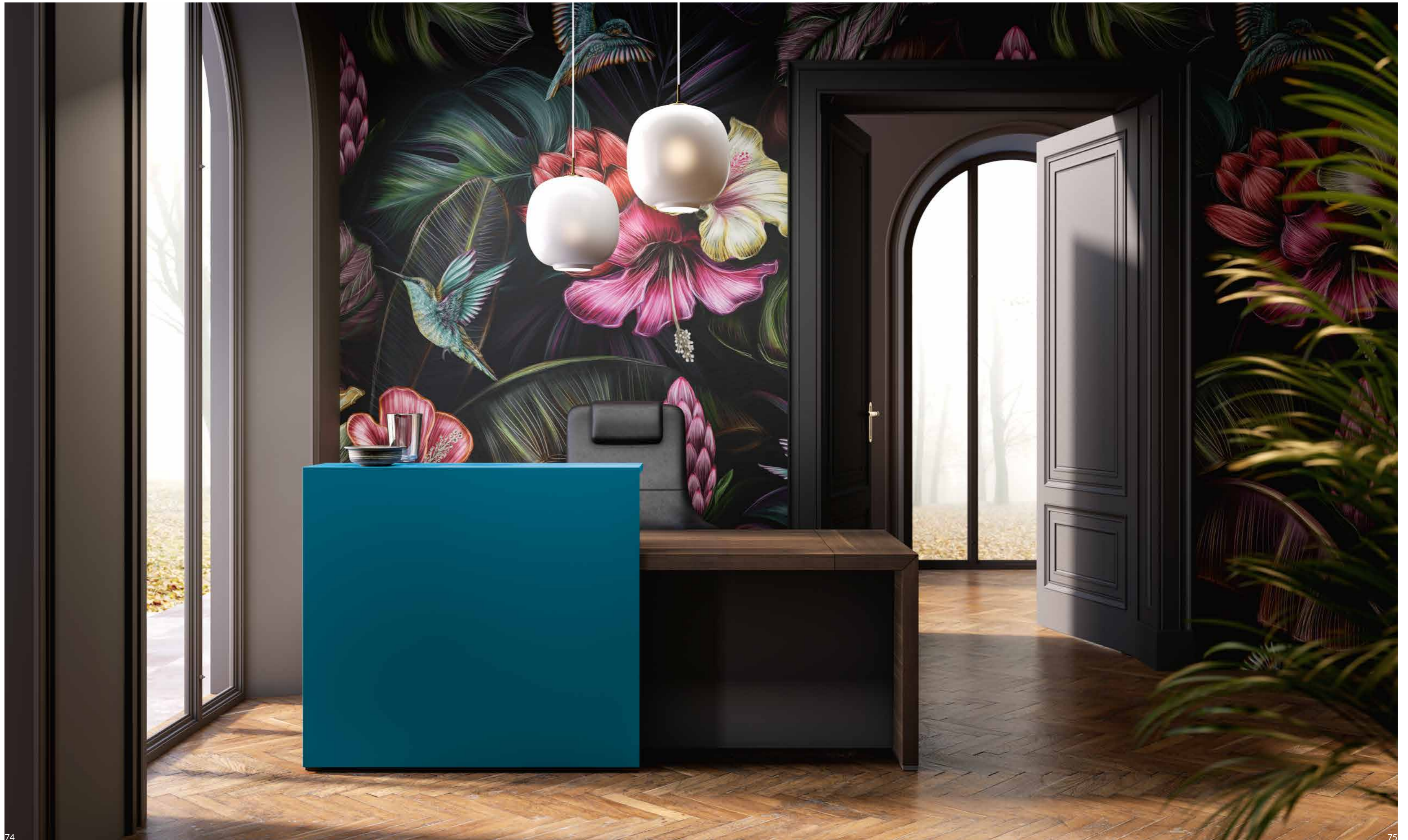

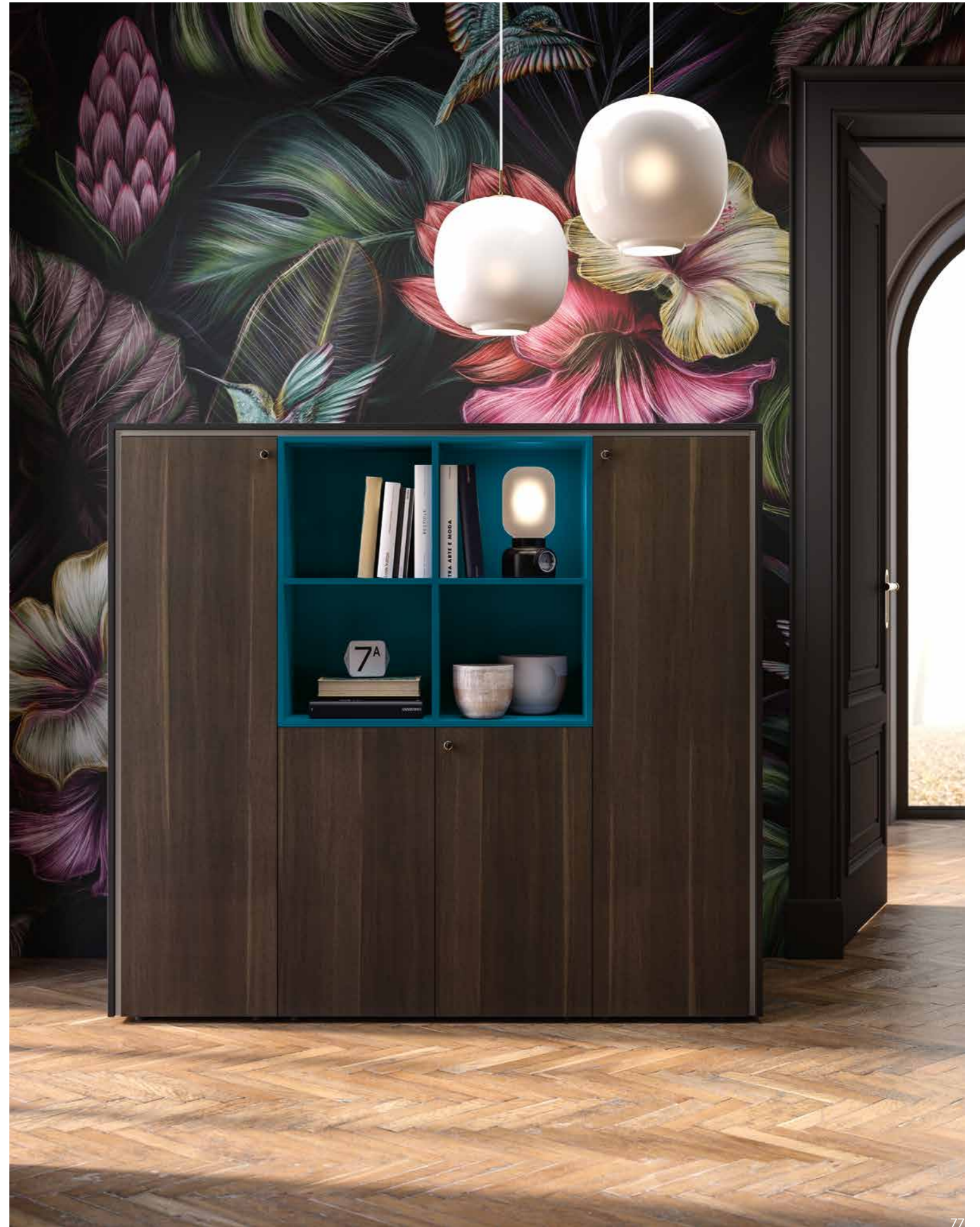





L'elemento reception si compone di due pannelli con giunzione a 45° che fungono da supporto al vetro lucido retro-laccato, entrambi in finitura GRIGIO FANGO.

The reception element consists of two panels with 45° junctions that act as a support for the glossy back-lacquered glass, both in MUD GRAY finish.

L'élément réception se compose de deux panneaux avec jonction à 45° qui servent de support au verre poli rétro-laqué, les deux en finition GRIS BOUE.







Il nuovo contenitore FRAME crea abbinamenti materici nuovi ed esclusivi. L'anta Laminam® NOIR DESIR si sposa perfettamente con le nuance dell'essenza EUCALIPTO, la finitura BRONZO del distanziale e il NERO del telaio.

The new FRAME container creates new and exclusive material combinations. The Laminam® NOIR DESIR door blends perfectly with the nuances of the EUCALYPTUS wood finish, the BRONZE finish of the spacer and the BLACK of the frame.

La nouvelle armoire FRAME crée des combinaisons de matériaux nouvelles et exclusives. La porte Laminam® NOIR DESIR se marie parfaitement avec les nuances de l'essence EUCALYPTUS, la finition BRONZE de l'entretoise et le NOIR du cadre.



Il tavolo caffè BOLD58 è un elemento immancabile per un ambiente ufficio prestigioso e accogliente. Continuità di forme e finiture tra gli articoli della collezione per uno spazio coordinato dedicato anche all'ospitalità.

The BOLD58 coffee table is an essential element for a prestigious and welcoming office environment. Continuity of shapes and finishes among the items in the collection for a coordinated space also dedicated to hospitality.

La table à café BOLD58 est un élément incontournable pour un environnement de bureau prestigieux et accueillant. Continuité des formes et des finitions entre les articles de la collection pour un espace coordonné dédié également à l'hospitalité.

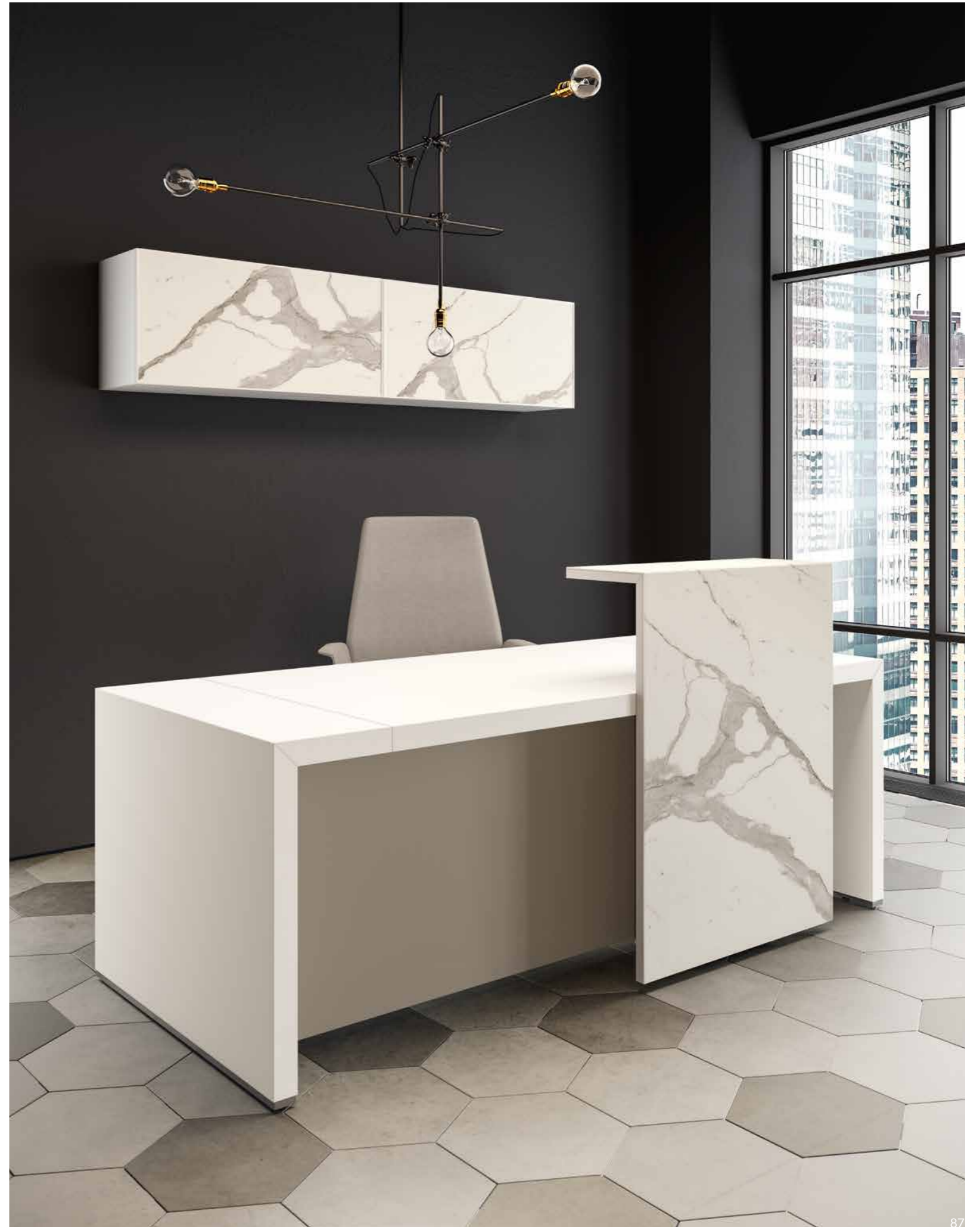

Il Laminam® BIANCO STATUARIO riveste l'elemento reception BIANCO DANCE, donando esclusività e classe all'area accoglienza.

Laminam® WHITE STATUARY covers the WHITE DANCE reception element, giving exclusivity and class to the reception area.

Le Laminam® BLANC STATUAIRE revêt l'élément réception BLANC DANCE, en donnant exclusivité et classe à l'espace accueil.



Il Laminam® BIANCO STATUARIO impreziosisce anche gli elementi pensili, incorniciato dal telaio in alluminio BIANCO.

Laminam® WHITE STATUARY also embellishes the wall units, framed by the WHITE aluminum frame.

Le Laminam® BLANC STATUAIRE enrichit également les éléments suspendus, encadrés par le cadre en aluminium BLANC.



TECHNICAL

Fascino ed eleganza.
Le combinazioni di componenti, materiali, finiture e colori determinano ambienti ufficio dal forte impatto estetico, assicurando una funzionalità originale e raffinata.

Charm and elegance.
The combinations of components, materials, finishes and colors determine office environments with a strong aesthetic impact, ensuring original and refined functionality.

Charme et élégance.
Les combinaisons de composants, matériaux, finitions et couleurs déterminent des environnements de bureau au fort impact esthétique, en assurant une fonctionnalité originale et raffinée.



MELAMINICO | MELAMINE | MÉLAMINE



N3NB
Noce Boheme
Walnut Boheme
Noyer Boheme



N3EU
Eucalipto
Eucalyptus
Eucalyptus



N3NJ
Nero Jazz
Black Jazz
Noir Jazz



N2GF
Grigio Fango
Mud Grey
Gris Boue

METALLO | METAL | MÉTAL



M2TT
Titanio
Titanium
Titane



M2BZ
Bronzo
Bronze
Bronze

LACCATO | LACQUERED | LAQUÉ



L2SI
Senape Italiana
Italian Mustard
Moutarde Italienne



L2CS
Cipria Scuro
Dark Powder
Poudre Foncée



L2VO
Verde Oliva
Olive Green
Vert Olive



L2OT
Ottanio
Teal
Octane

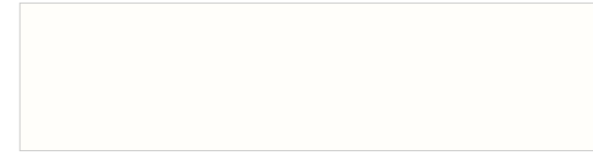

L2BD
Bianco Dance
White Dance
Blanc Dance



L2GF
Grigio Fango
Mud Grey
Gris Boue



L2MS
Marsala
Marsala
Marsala

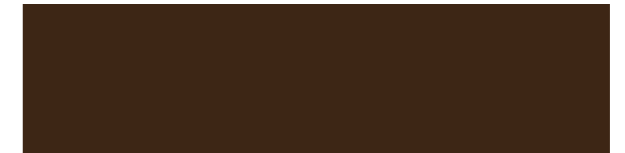

L2MK
Moka
Moka
Moka



L2TT
Titanio
Titanium
Titane



L2NE
Nero Elegante
Smart Black
Noir Éléphant

VETRO | GLASS | VERRE



E1EC
Extrachiaro
Extra Light
Extra Clair

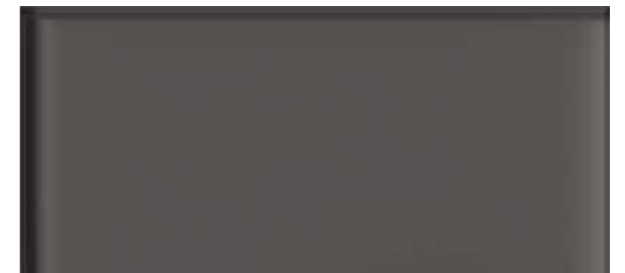

V1GE
Grigio Europeo
European Grey
Gris Européen



VETRO LACCATO | LACQUERED GLASS | VERRE LAQUÉ

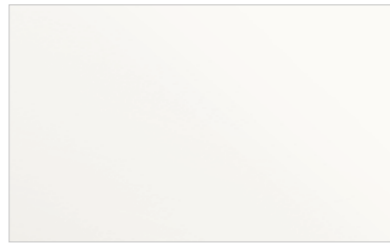

E1BD | E3BD
Bianco Dance
White Dance
Blanc Dance



E1GF | E3GF
Grigio Fango
Mud Grey
Gris Boue



E1MS | E3MS
Marsala
Marsala
Marsala



E1TT | E3TT
Titanio
Titanium
Titane



V1NE | V3NE
Nero Elegante
Smart Black
Noir Élegant

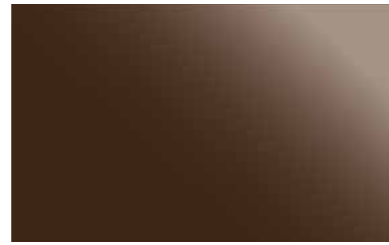

V1MK | V3MK
Moka
Moka
Moka

VETRO LACCATO
LACQUERED GLASS
VERRE LAQUÉ



VETRO LACCATO NO-PRINT
NO-PRINT LACQUERED GLASS
VERRE LAQUÉ NO-PRINT



LAMINAM® | LAMINAM® | LAMINAM®



K1BS
Bianco Statuario Lucido
Polished White Statuary
Blanc Statuaire Brillant

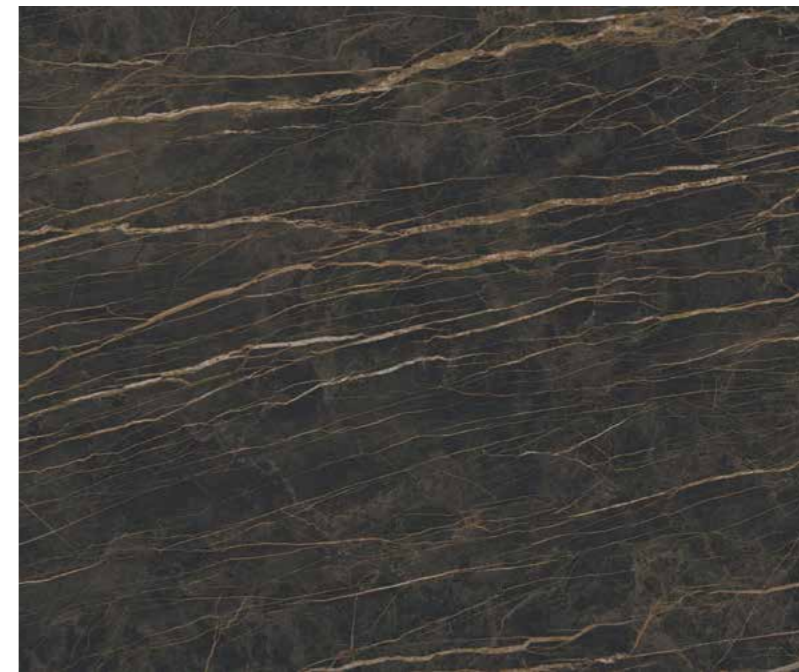

K1ND
Noir Desir Lucido
Polished Noir Desir
Noir Desir Brillant

CASSETTIERA | PEDESTAL | CAISSON

La cassettera BOLD58 si configura in tre soluzioni materiche:
 - in versione standard in essenza;
 - in versione standard laccata;
 - con struttura in finitura NERO ELEGANTE abbinata ai frontali dei cassetti in Laminam® NOIR DESIR e telaio in alluminio NERO, o con struttura BIANCO DANCE abbinata ai frontali in Laminam® BIANCO STATUARIO e telaio in alluminio BIANCO.

The BOLD58 drawer pedestal is configured in three material solutions:
 - in standard version in wood finish;
 - in standard lacquered solution;
 - with SMART BLACK finish structure combined with Laminam® NOIR DESIR drawer fronts and BLACK aluminum frame, or with WHITE DANCE structure combined with Laminam® WHITE STATUARY fronts and WHITE aluminum frame.

Le caisson BOLD58 est configuré en trois solutions de matériaux:
 - en version standard en essence;
 - en solution standard laquée,
 - avec structure en finition NOIR ÉLÉGANT combinée aux façades des tiroirs en Laminam® NOIR DESIR et cadre en aluminium NOIR, ou avec structure BLANC DANCE combinée aux façades en Laminam® BLANC STATUAIRE et cadre en aluminium BLANC.



MOBILE DI SERVIZIO | SERVICE UNIT | MEUBLE DE SERVICE

L'ampio mobile di servizio BOLD58 in soluzione freestanding è caratterizzato da una base in metallo in finitura TITANIO o BRONZO, da una struttura esterna con ante in essenza o laccata e da due cassetti centrali in NERO JAZZ o GRIGIO FANGO. In alternativa, per una soluzione contemporanea, la versione totalmente laccata di struttura, ante e cassetti.

The large BOLD58 service cabinet in a freestanding solution is characterized by a metal base in TITANIUM or BRONZE finish, an external structure with wood finish or lacquered doors and two central drawers in BLACK JAZZ or MUD GRAY. Alternatively, for a contemporary solution, the fully lacquered version of the structure, doors and drawers.

Le grand meuble de service BOLD58 en solution autoportant se caractérise par une base en métal en finition TITANE ou BRONZE, une structure externe avec portes en essence ou laquée et deux tiroirs centraux en NOIR JAZZ ou GRIS BOUE. Alternativement, pour une solution contemporaine, la version totalement laquée de la structure, des portes et des tiroirs.



MADIA FRAME | SIDEBOARD FRAME | BUFFET FRAME

Nella collezione BOLD58 il contenimento madia si arricchisce di dettagli, trasformandosi in Madia FRAME. Qui gli elementi di finitura si compongono di distanziali TITANIO o BRONZO e una combinazione di top e fianchi in essenza, caratterizzati da contrasti unici di orientamento delle venature.

In the BOLD58 collection, the sideboard is enriched with details, becoming in this way the FRAME sideboard. Here the finishing elements are made up of TITANIUM or BRONZE spacers and a combination of wood finish top and sides, characterized by unique contrasts of grain orientation.

Dans la collection BOLD58 le rangement du buffet s'enrichit de détails, se transformant en Buffet FRAME. Ici, les éléments de finition se composent d'entretoises TITANE ou BRONZE et une combinaison de tops et de panneaux latéraux en essence, caractérisés par des contrastes uniques d'orientation des veinures.



MADIA CON BASE IN METALLO | SIDEBOARD WITH METAL BASE | BUFFET AVEC BASE EN MÉTAL

Vasta gamma di finiture per la nuova madia BOLD58 con base in metallo, in finitura TITANIO o BRONZO. Presentata in tre soluzioni di composizione, combina una struttura esterna in essenza o in versione laccata con giunzioni a 45°, pensili con cassa in melaminico o laccata e ante in quattro varianti di materiale: in essenza, laccate, in vetro con telaio in alluminio, in Laminam® con telaio in alluminio. Opzionale di grande impatto è il kit di illuminazione led inseribile all'interno degli elementi pensile con ante in vetro.

Wide range of finishes for the new BOLD58 sideboard with metal base, in TITANIUM or BRONZE finish. Presented in three composition solutions, it combines an external structure in wood finish or in lacquered version with 45° connections, wall units with melamine or lacquered case and doors in four material variants: in wood finish, lacquered, in glass with aluminum frame, in Laminam® with aluminum frame. High-impact optional is the LED lighting kit that can be integrated inside the wall units with glass doors.

Large gamme de finitions pour la nouvelle armoire BOLD58 avec base en métal, en finition TITANE ou BRONZE. Présentée en trois solutions de composition, elle combine une structure externe en essence ou en version laquée avec des joints à 45°, des meubles suspendus avec structure en mélaminé ou laqué et portes en quatre finitions : en essence, laqué, en verre avec cadre en aluminium, en Laminam® avec cadre en aluminium. Option de grand impact est le kit d'éclairage led insérable à l'intérieur des éléments suspendus avec portes en verre.



CONTENITORE FRAME | STORAGE UNIT FRAME | ARMOIRE FRAME

Novità per il contenitore BOLD58 in versione FRAME. Il top e i fianchi di finitura, in essenza, si rinnovano attraverso una composizione originale di contapposizioni venatura, combinandosi inoltre a un distanziale in versione TITANIO o BRONZO.

News for the BOLD58 container in the FRAME version. The top and the finishing sides, in wood finish, are renewed through an original composition of grain counterpoints, also combined with a spacer in TITANIUM or BRONZE version.

Nouveauté pour l'armoire BOLD58 en version FRAME. Le top et les côtés de finition, en essence, se renouvellent par une composition originale de contrastes de veinures, en se combinant également à une entretoise en version TITANE ou BRONZE.



LIBRERIA | BOOKCASE | BIBLIOTHÈQUE

La nuova Libreria GATE è una soluzione innovativa, personalizzabile nella configurazione, nelle dimensioni e nei materiali. Una solida struttura esterna portante in metallo, in finitura TITANIO o BRONZO, racchiude divisori e ripiani in essenza o laccati, per una soluzione totalmente a giorno. A completamento i pensili, anch'essi in versione a giorno, con ante in essenza, laccate, in vetro con telaio in alluminio o in Laminam® con telaio in alluminio. Elemento di esclusività l'accessorio di illuminazione interna led per la soluzione con ante in vetro.

The new GATE Library is an innovative solution, customizable in configuration, dimensions and materials. A solid external metal structure, in TITANIUM or BRONZE finish, encloses dividers and shelves in wood finish or lacquered, for a totally open solution. To complete the wall units, also in the open version, with doors in wood finish, lacquered, glass with aluminum frame or in Laminam® with aluminum frame. An element of exclusivity is the internal LED lighting accessory for the solution with glass door.

La nouvelle Bibliothèque GATE est une solution innovante, personnalisable dans la configuration, les dimensions et les matériaux. Une structure extérieure solide portant en métal, en finition TITANIUM ou BRONZE, renferme des diviseurs et des étagères en essence ou laqués, pour une solution totalement à jour. En complément des unités murales, également en version à jour, avec portes en essence, laqué, en verre avec cadre en aluminium ou en Laminam® avec cadre en aluminium. Élément d'exclusivité l'accessoire d'éclairage intérieur led pour la solution avec porte en verre.

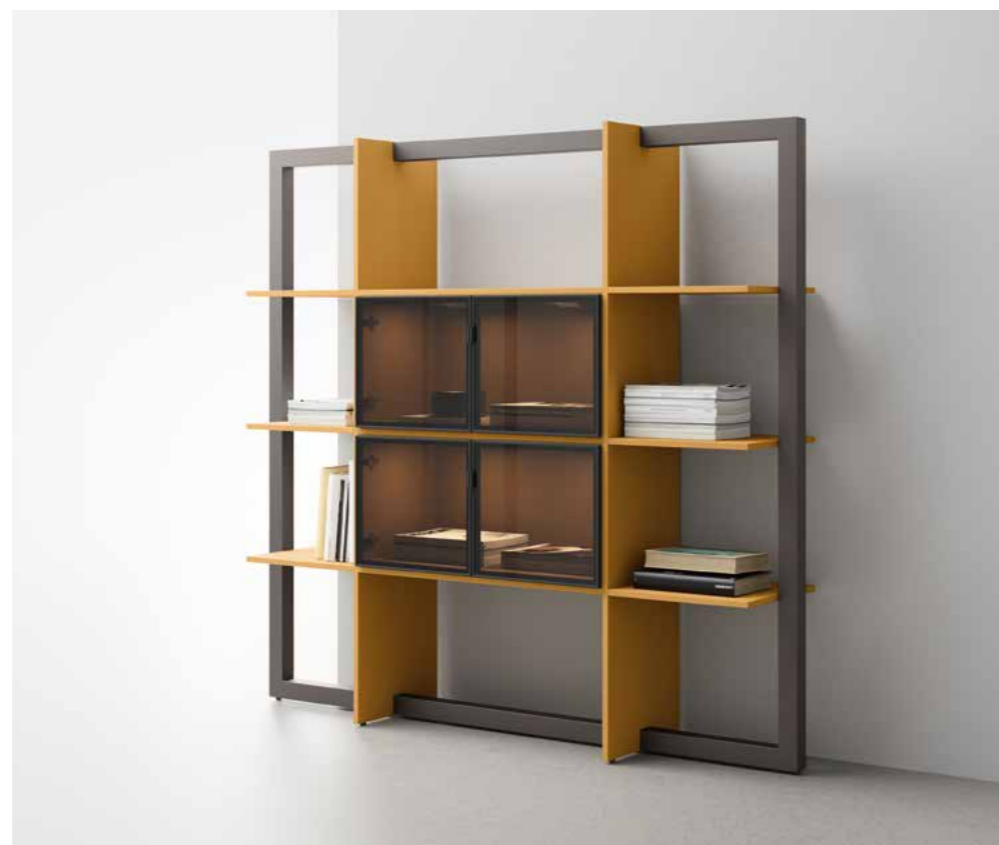

ELETRIFICAZIONE | CABLE MANAGEMENT | CÂBLAGE

Le scrivanie BOLD58 possono essere elettrificate grazie all'inserimento del passacavi VERSAPAD nell'elemento terminale del piano lavoro. Varie le tipologie di vertebra che permettono di contenere i cavi, per una pulizia e un ordine in linea con il design BOLD58.

The BOLD58 desks can host cable management thanks to the VERSAPAD top access in the terminal element of the worktop. Various types of cable tubes that allow to contain the cables, for cleaning and order in line with the BOLD58 design.

Les bureaux BOLD58 peuvent être électrifiés grâce à l'insertion du passe-câbles VERSAPAD dans l'élément terminal du plan de travail. Différents types de vertèbres qui permettent de contenir les câbles, pour un nettoyage et une commande en ligne avec le design BOLD58.



La cassettera integrata alla scrivania BOLD58 si completa di top access EXIT, per un passaggio cavi organizzato. Il foro passante, posizionato nella parte inferiore della cassettera, permette la corretta elettrificazione della postazione.

The drawer pedestal integrated into the BOLD58 desk is completed with EXIT top access, to allow for cable passage. The passing hole, positioned in the lower part of the drawer pedestal, offers the correct cable management integration.

Le caisson intégré au bureau BOLD58 est complétée par un top-accès EXIT, pour un passage de câbles organisé. Le trou passant, positionné dans la partie inférieure du caisson, permet l'électrification correcte du poste de travail.



ORIENTAMENTO VENA | WOOD VEIN ORIENTATION | ORIENTATION DU VEINURE

Una delle caratteristiche che rende unica la scrivania in essenza BOLD58 è rappresentata dall'orientamento vena degli elementi. La continuità della texture tra il fianco e la prima porzione del piano, congiunti tra loro a 45°, si pone in netto contrasto con l'orientamento dell'essenza del piano lavoro con sviluppo longitudinale. Un dettaglio di pregio che ne esalta il design.

One of the features that makes the BOLD58 desk in wood finish unique is represented by the orientation of the elements. The continuity of the texture between the side and the first portion of the top, joined together at 45° connection, stands in strong contrast to the orientation of the wood finish of the worktop with longitudinal development. A valuable detail that enhances the design.

Une des caractéristiques qui rend le bureau en essence BOLD58 unique est représenté par l'orientation de la veinure des éléments. La continuité de la texture entre le panneau latéral et la première partie du plateau, reliés entre eux à 45°, contraste fortement avec l'orientation de l'essence du plateau de travail avec développement longitudinal. Un détail précieux qui exalte son design.



Contrapposizione di texture, in essenza, che evidenzia l'accostamento dei piani, per una composizione originale delle superfici dal forte sviluppo orizzontale. In BOLD58 i tavoli riunione acquistano un carattere speciale e innovativo, completati da un sistema di elettrificazione centrale FLAP.

Contrast of textures, in wood finish, which highlights the juxtaposition of the tops, for an original composition of the surfaces with a strong horizontal development. In BOLD58 the meeting tables acquire a special and innovative character, completed by a central FLAP electrification system.

Contraste entre les texture, en essence, qui met en évidence la combinaison des plateaux, pour une composition originale des surfaces au fort développement horizontal. En BOLD58, les tables de réunion acquièrent un caractère spécial et innovant, complétées par un système d'électrification central FLAP.



ORIENTAMENTO VENA | WOOD VEIN ORIENTATION | ORIENTATION DU VEINURE

Gli elementi di finitura sono accostati tra loro per creare soluzioni estetiche nuove, dando vita alla Madia FRAME. Il fianco e il top laterale sono collegati tra loro tramite giunzione a 45°; questi due elementi, posizionati su piani differenti nello spazio, creano continuità grazie al medesimo orientamento vena. A contrasto la fiamma del top centrale, qui posta longitudinalmente. Il distanziale in finitura TITANIO o BRONZO è il dettaglio che arricchisce l'intera composizione.

The finishing elements are combined together to create new aesthetic solutions, giving life to the FRAME sideboard. The side and the side top are connected to each other through a 45° connection; these two elements, positioned on different planes in the space, create continuity thanks to the same vein orientation. In contrast, the flame of the central top, here placed longitudinally. The spacer in TITANIUM or BRONZE finish is the detail that enriches the entire composition.

Les éléments de finition sont combinés pour créer de nouvelles solutions esthétiques, donnant vie au Buffet FRAME. Le top et le panneau latéral sont reliés entre eux par jonction à 45°; ces deux éléments, positionnés sur des plans différents dans l'espace, créent continuité grâce à la même orientation de la veinure. Par opposition la veinure du top central, placée longitudinalement. L'entretoise en finition TITANE ou BRONZE est le détail qui enrichit toute la composition.



Il Contenitore FRAME sostituisce i classici top e fianchi di finitura con una composizione particolare e ricercata che lo contraddistingue dal Contenitore Standard e ne esalta la suddivisione dei vari elementi: fianchi in essenza dall'orientamento venatura orizzontale, top laterali che danno continuità alla texture dei fianchi, top centrali con venature che si contrappongono a quelli laterali, distanziali in finitura metallo TITANIO o BRONZO.

The FRAME container replaces the classic finishing tops and sides with a particular and refined composition that distinguishes it from the Standard Container and enhances the subdivision of the various elements: sides in wood finish with a horizontal grain orientation, side tops that give continuity to the texture of the sides, central top with veins that contrast with the side ones, spacers in TITANIUM or BRONZE metal finish.

L'Armoire FRAME remplace les tops classiques et les côtés de finition avec une composition particulière et recherchée qui le distingue de l'Armoire Standard et en exalte la subdivision des différents éléments: côtés en essence avec orientation de la veinure horizontal, top latéraux qui donnent continuité à la texture des côtés, tops centraux avec veinures qui s'opposent à ceux latéraux, entretoises en finition métal TITANE ou BRONZE.

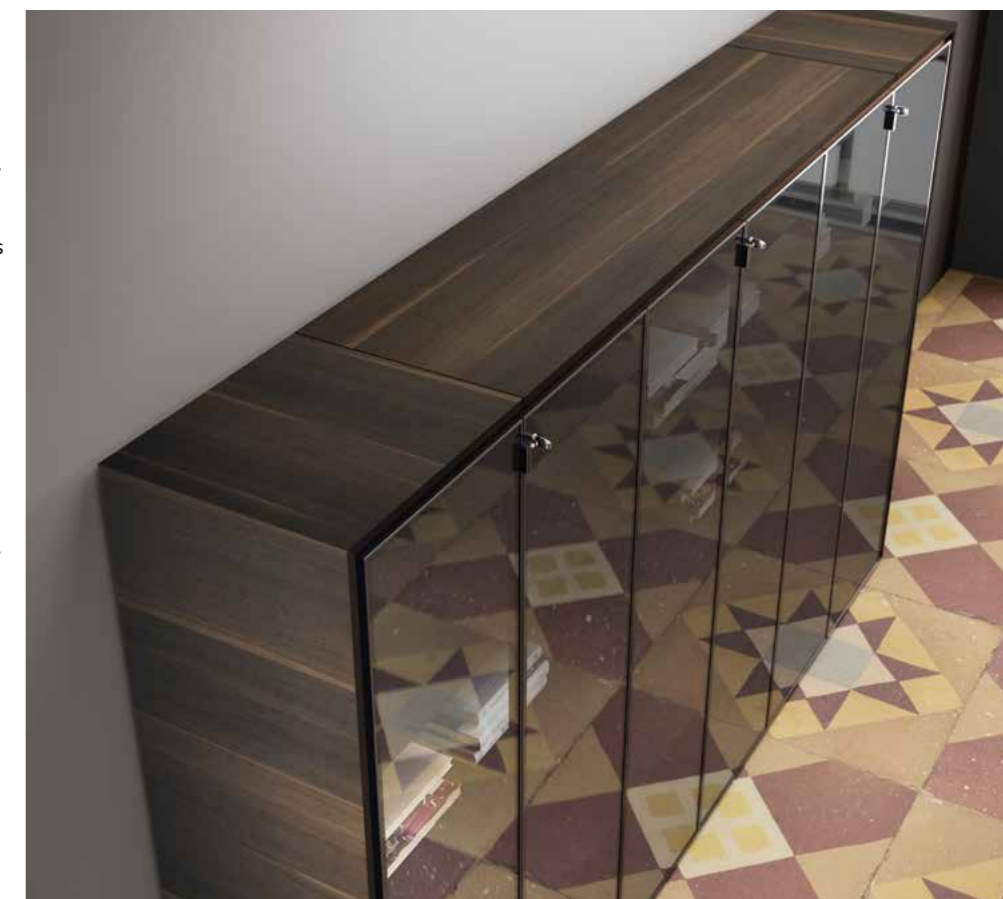

COMPONENTI SCRIVANIA | DESK COMPONENTS | COMPOSANTS BUREAU

- 1. **Piano**
Worktop
Plateau
- 2. **Fianco laterale e piano**
Side panel and worktop
Panneau latéral et plateau
- 3. **Distanziale in vetro**
Glass spacer element
Entretoise en verre
- 4. **Base scrivania**
Desk base
Base bureau
- 5. **Zoccolo**
Plinth
Plinthe
- 6. **Mobile di servizio**
Service unit
Meuble de service
- 7. **Cassettiera**
Drawer pedestal
Caisson
- 8. **Supporto**
Support
Support

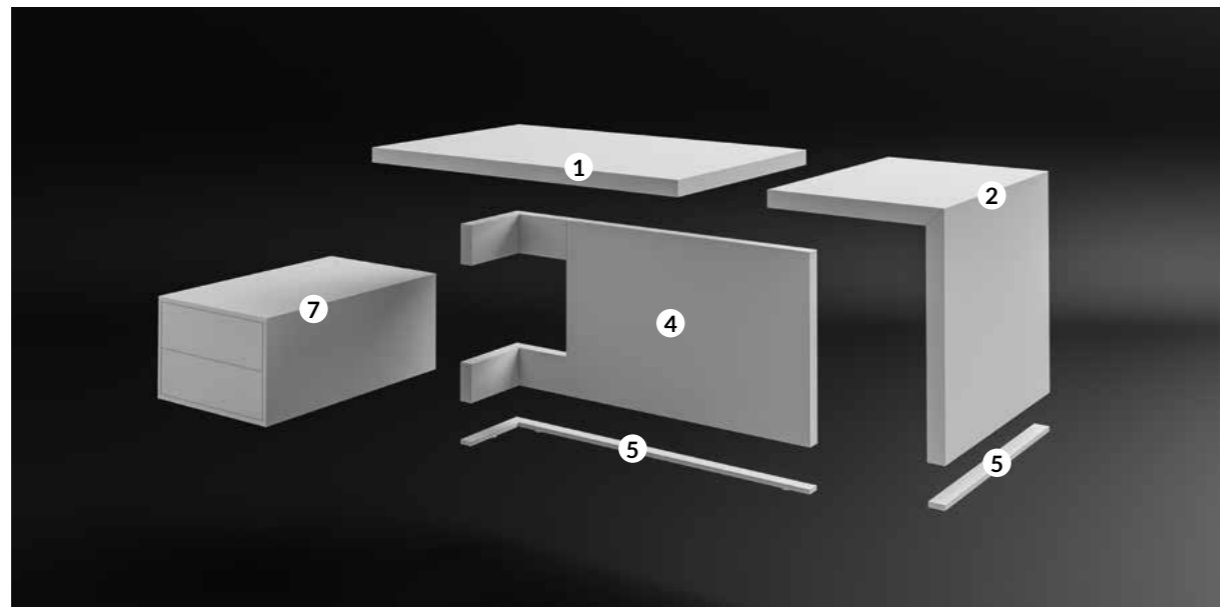
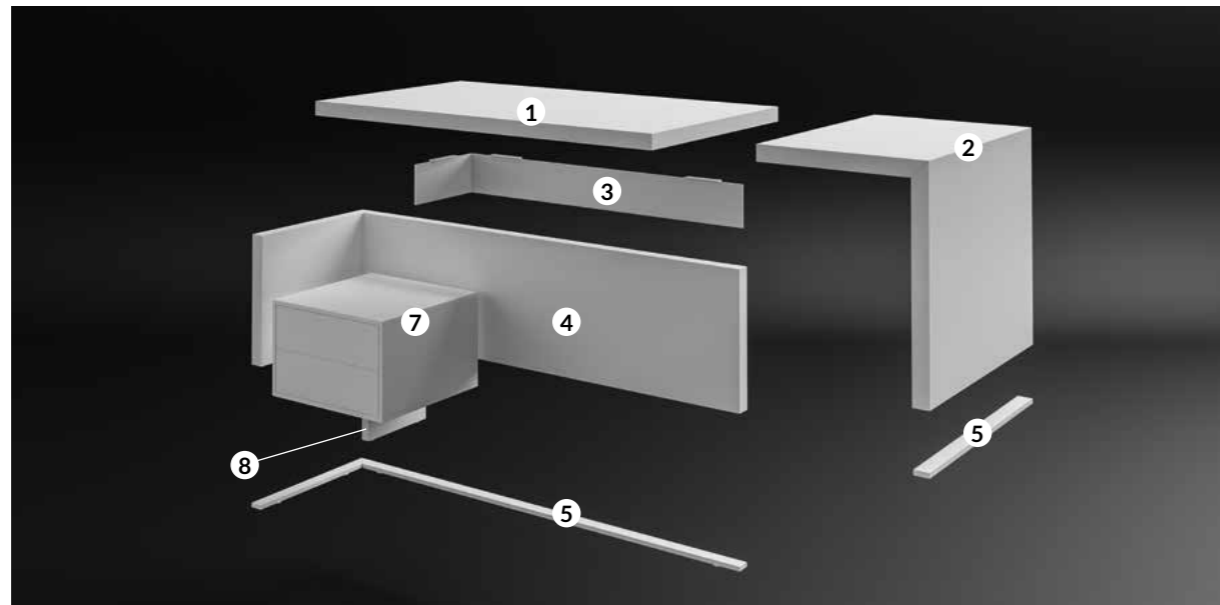
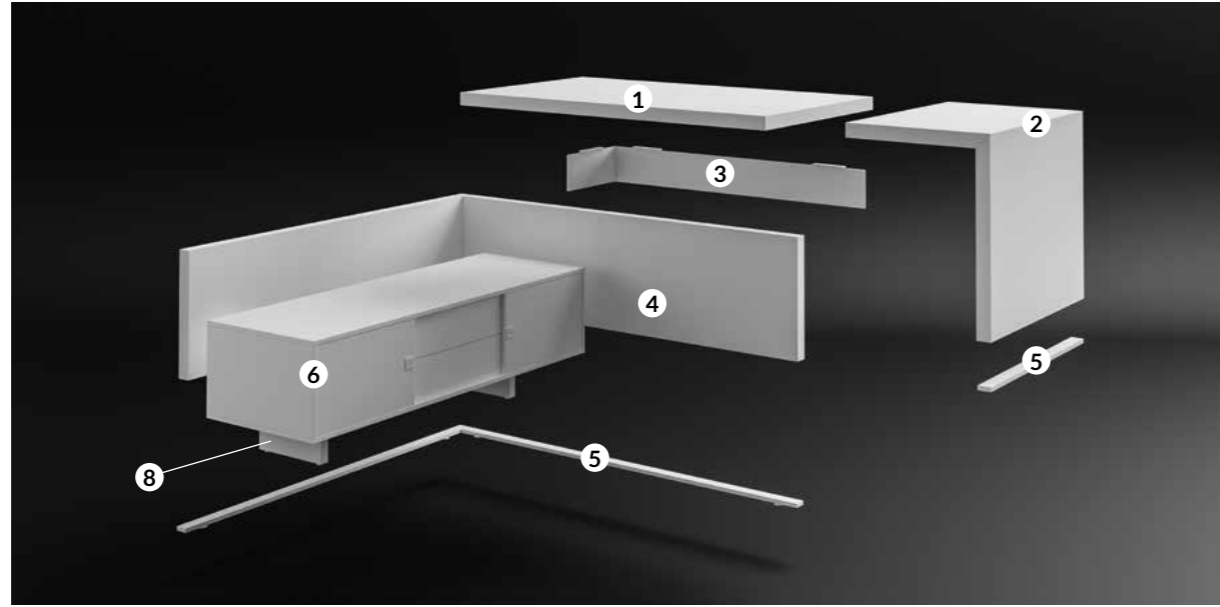

COMPONENTI SCRIVANIA | DESK COMPONENTS | COMPOSANTS BUREAU

- 1. **Piano**
Worktop
Plateau
- 2. **Fianco laterale e piano**
Side panel and worktop
Panneau latéral et plateau
- 3. **Distanziale in vetro**
Glass spacer element
Entretoise en verre
- 4. **Base scrivania**
Desk base
Base bureau
- 5. **Zoccolo**
Plinth
Plinthe
- 6. **Modesty panel melaminico**
Melamine modesty panel
Voile de fond en mélaminé
- 6. **Modesty panel laccato**
Lacquered modesty panel
Voile de fond laqué
- 6. **Modesty panel in vetro**
Glass modesty panel
Voile de fond en verre
- 6. **Modesty panel in Laminam®**
Laminam® modesty panel
Voile de fond en Laminam®
- 7. **Allungo**
Return
Retour
- 8. **Supporto in metallo**
Metal support
Support en métal

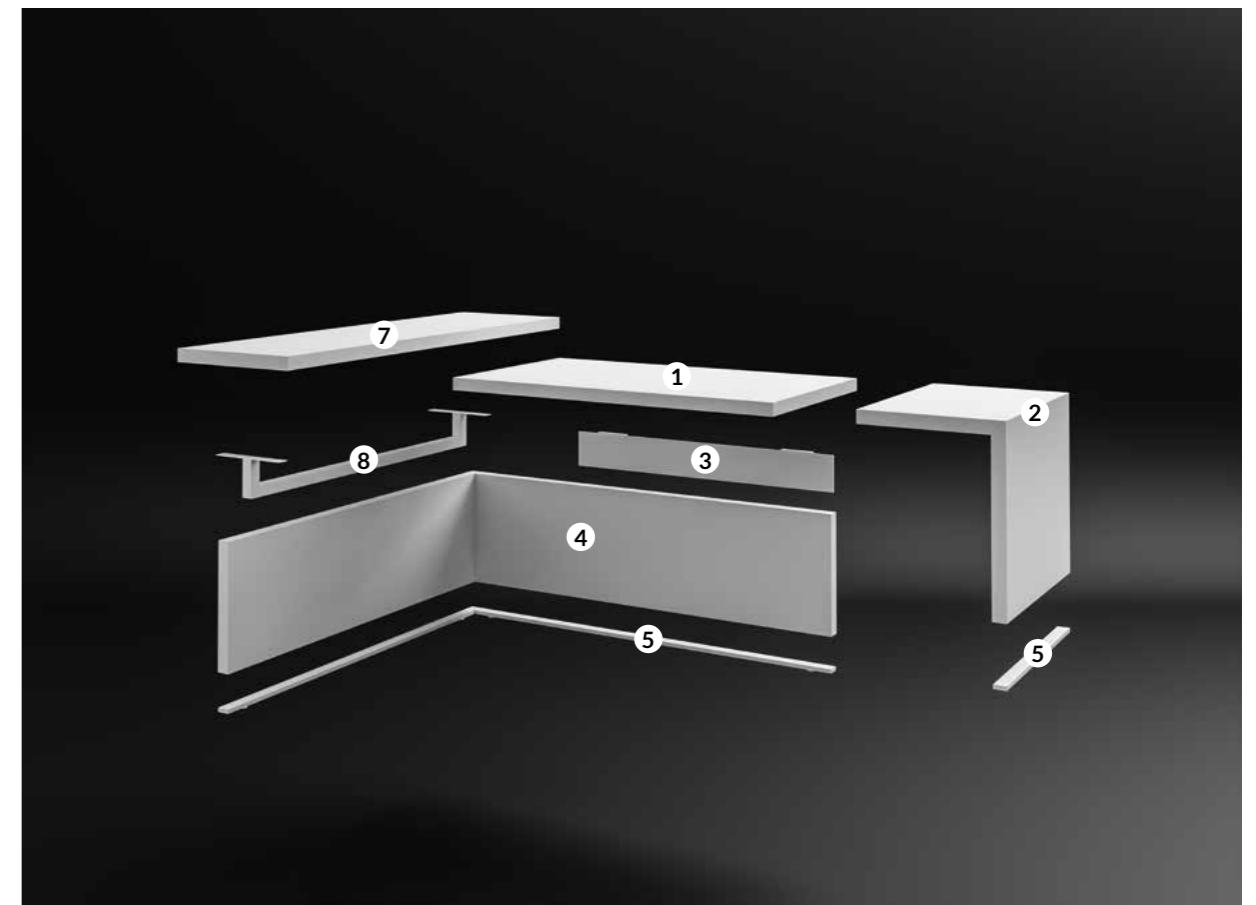

Scrivania e Tavolo riunione con piano in essenza | Desk and Meeting table with wood finish desktop | Bureau et Table de réunion avec plateau en essence

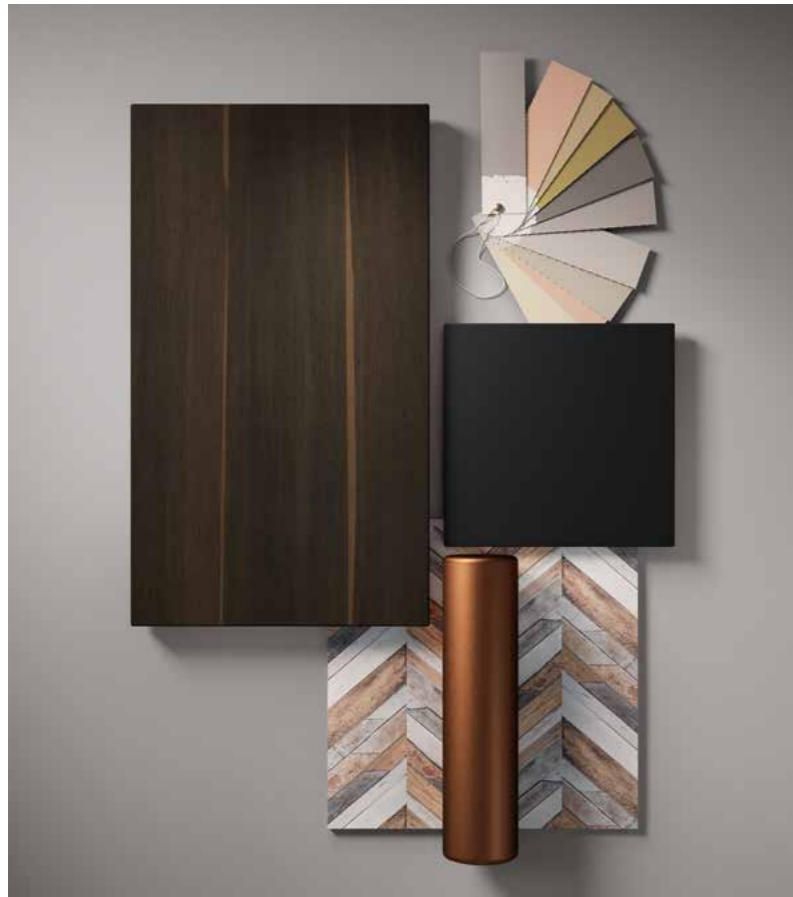

Madia, Contenitore e Reception | Sideboard, Storage unit and Reception | Buffet, Armoire et Réception

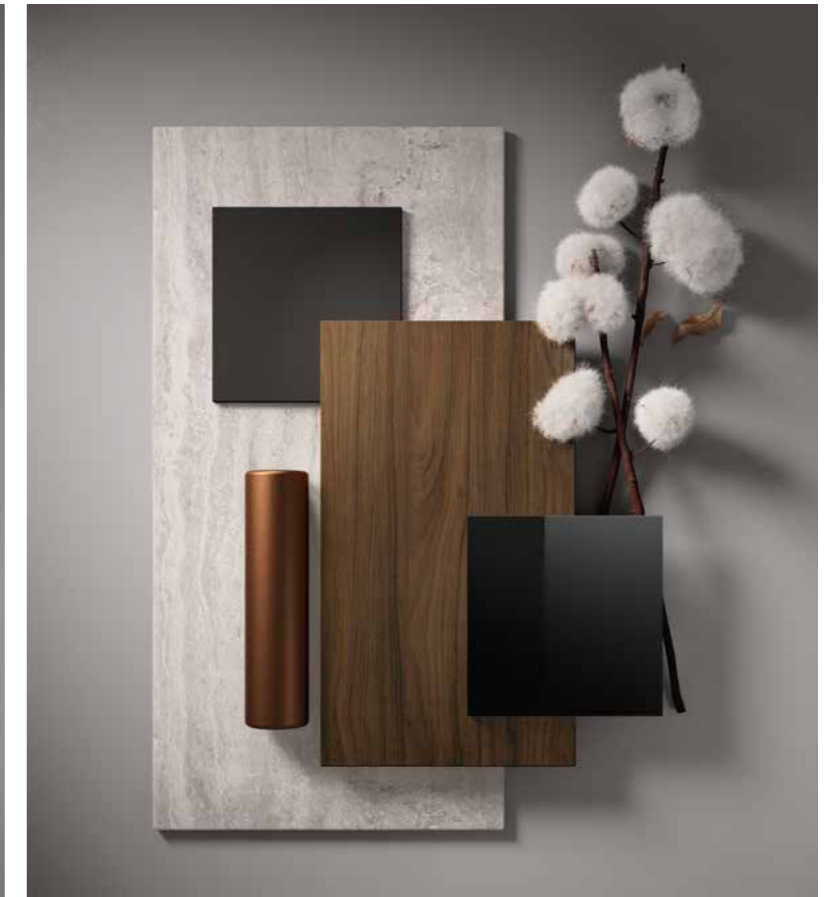

Scrivania e Tavolo riunione con piano laccato | Desk and Meeting table with lacquered desktop | Bureau et Table de réunion avec plateau laqué

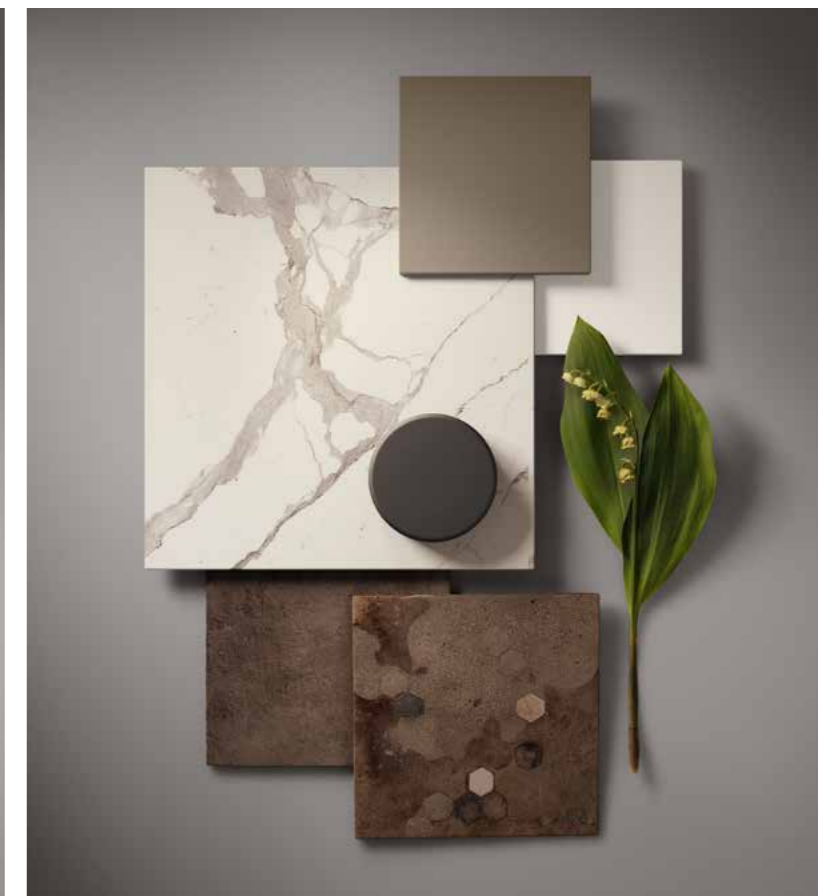
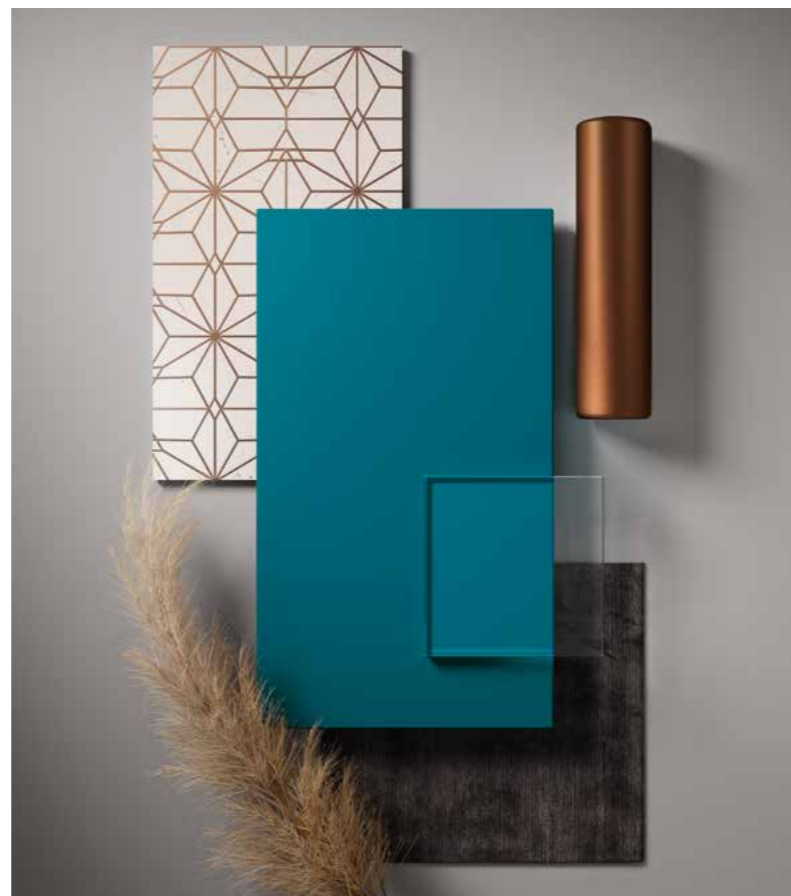

ABACUS

Scrivania BRIDGE | BRIDGE Desk | Bureau BRIDGE

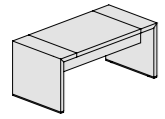

L 180 P 90 H 78

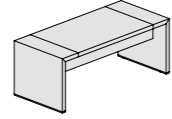

L 200 P 90 H 78

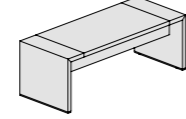

L 220 P 90 H 78

Scrivania IMPERIAL | IMPERIAL Desk | Bureau IMPERIAL

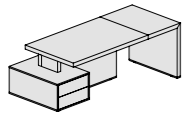

L 230 (200) P 90 H 78

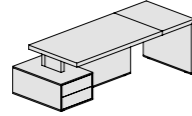

L 250 (220) P 90 H 78

Scrivania FUSION | FUSION Desk | Bureau FUSION

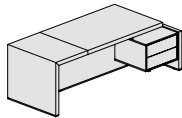

L 236 (200) P 90 H 78

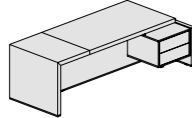

L 256 (220) P 90 H 78

Scrivania LEAVEN | LEAVEN Desk | Bureau LEAVEN

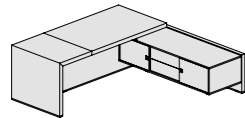

L 236 (200) P 200 (90) H 78

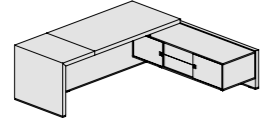

L 256 (220) P 200 (90) H 78

Scrivania DECK | DECK Desk | Bureau DECK

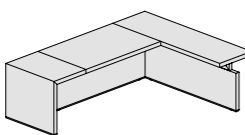

L 260 (200) P 200 (90) H 78

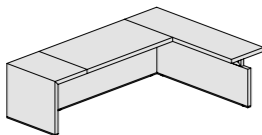

L 280 (220) P 200 (90) H 78

ABACUS

Tavolo riunione | Meeting table | Table de réunion

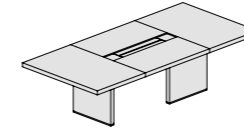

L 300 P 140 H 78

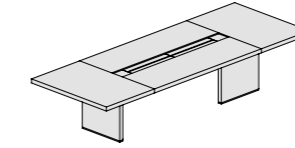

L 380 P 140 H 78

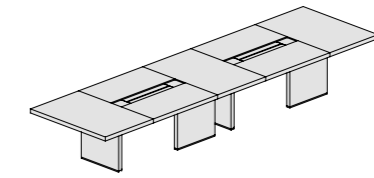

L 510 P 140 H 78

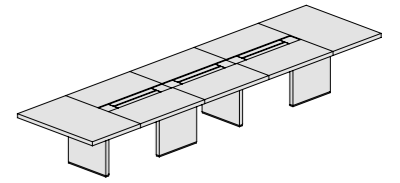

L 540 P 140 H 78
L 620 P 140 H 78

Tavolo riunione con vetro | Meeting table with glass desktop | Table de réunion avec verre

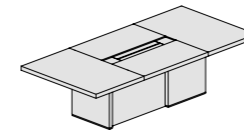

L 300 P 140 H 78

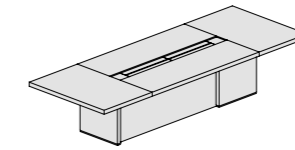

L 380 P 140 H 78

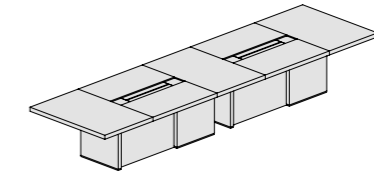

L 510 P 140 H 78

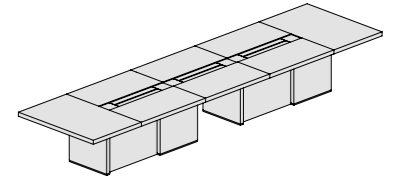

L 540 P 140 H 78
L 620 P 140 H 78

Tavolo riunione con base in metallo | Meeting table with metal base | Table de réunion avec base en métal

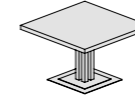

L 120 P 120 H 78

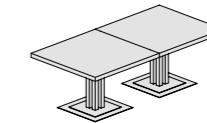

L 240 P 120 H 78

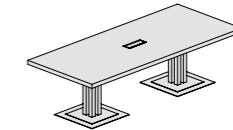

L 280 P 120 H 78

Tavolo caffè | Coffee table | Table à café



L 64 P 60 H 45

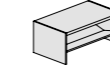

L 104 P 60 H 45

Mensola reception | Reception Shelf | Étagère banque d'accueil

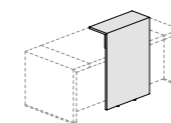

L 80 P 30 H 107

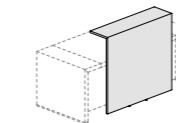

L 120 P 30 H 107

Cassettiera | Pedestal | Caisson



L 41,5 P 55 H 54



L 41,5 P 55 H 54



L 41,5 P 55 H 54

Mobile di servizio con base in metallo | Service unit with metal base | Meuble de service avec base en métal

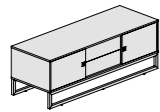

L 169 P 60 H 59

Mobile di servizio | Service unit | Meuble de service

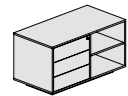

L 115 P 60 H 62

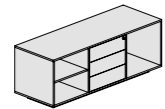

L 169 P 60 H 62

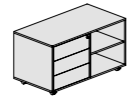

L 115 P 60 H 62

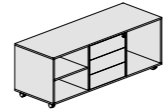

L 169 P 60 H 62

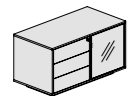

L 115 P 60 H 62

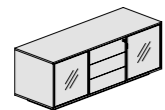

L 169 P 60 H 62

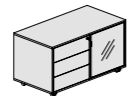

L 115 P 60 H 62

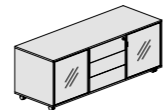

L 169 P 60 H 62

Pensile | Wall unit | Élément de rangement suspendu

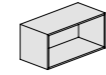

L 90 P 43 H 41,6
L 90 P 33 H 41,6
L 45 P 43 H 41,6
L 45 P 33 H 41,6

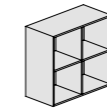

L 90 P 43 H 83,2
L 90 P 33 H 83,2

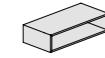

L 90 P 43 H 20,8
L 90 P 33 H 20,8
L 45 P 43 H 20,8
L 45 P 33 H 20,8

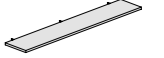

L 180 P 32 H 3,8
L 135 P 32 H 3,8
L 90 P 32 H 3,8
L 180 P 32 H 2,5
L 135 P 32 H 2,5
L 90 P 32 H 2,5

Pensile con anta | Wall unit with front | Élément de rangement suspendu avec porte

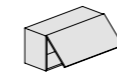

L 90 P 35 H 41,6
L 45 P 35 H 41,6

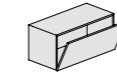

L 90 P 45 H 41,6
L 90 P 35 H 41,6
L 45 P 45 H 41,6
L 45 P 35 H 41,6

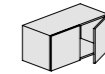

L 90 P 45 H 41,6
L 90 P 35 H 41,6
L 45 P 45 H 41,6
L 45 P 35 H 41,6

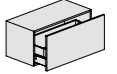

L 90 P 45 H 41,6
L 45 P 45 H 41,6

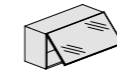

L 90 P 35 H 41,6
L 45 P 35 H 41,6

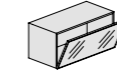

L 90 P 45 H 41,6
L 90 P 35 H 41,6
L 45 P 45 H 41,6
L 45 P 35 H 41,6

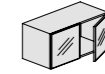

L 90 P 45 H 41,6
L 90 P 35 H 41,6
L 45 P 45 H 41,6
L 45 P 35 H 41,6

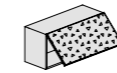

L 90 P 35 H 41,6
L 45 P 35 H 41,6

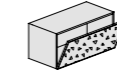

L 90 P 45 H 41,6
L 90 P 35 H 41,6
L 45 P 45 H 41,6
L 45 P 35 H 41,6

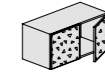

L 90 P 45 H 41,6
L 90 P 35 H 41,6
L 45 P 45 H 41,6
L 45 P 35 H 41,6

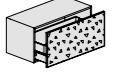

L 90 P 45 H 41,6
L 45 P 45 H 41,6

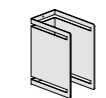

L 20 P 35 H 41,6

Libreria | Bookcase | Bibliothèque

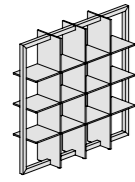

L 198 P 42,5 H 186

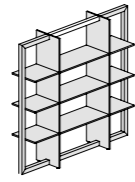

L 196 P 42,5 H 186

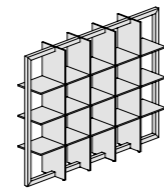

L 245 P 42,5 H 186

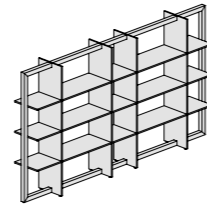

L 335 P 42,5 H 186

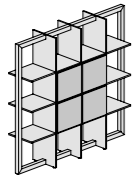

L 198 P 42,5 H 186

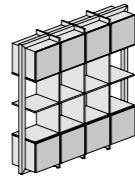

L 198 P 42,5 H 186

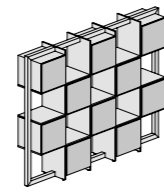

L 245 P 42,5 H 186

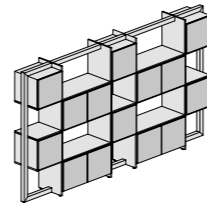

L 335 P 42,5 H 186

Madia con base in metallo | Sideboard with metal base | Buffet avec base en métal

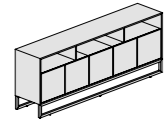

L 229 P 46 H 86

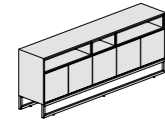

L 229 P 46 H 86

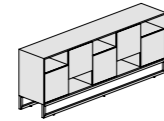

L 229 P 46 H 86

Madia | Sideboard | Buffet

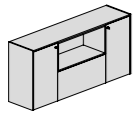

L 180 P 45 H 85

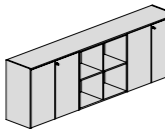

L 270 P 45 H 85

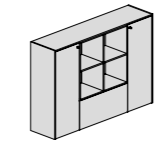

L 180 P 45 H 127

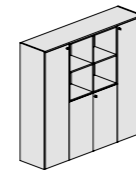

L 180 P 45 H 168

Top e fianchi | Top and sides | Top et côtés

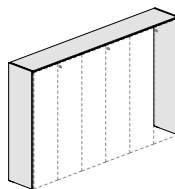

H 210
H 168
H 127
H 108
H 85

Top e fianchi FRAME | FRAME Top and sides | Top et côtés FRAME

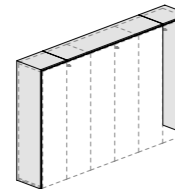

H 170
H 129
H 110
H 87

Contenitore | Storage unit | Armoire



L 90 P 43 H 85
L 45 P 43 H 85

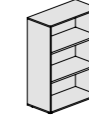

L 90 P 43 H 127
L 45 P 43 H 127

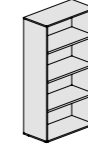

L 90 P 43 H 168
L 45 P 43 H 168

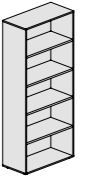

L 90 P 43 H 210
L 45 P 43 H 210

Contenitore con ante | Storage unit with doors | Armoire avec portes



L 90 P 45 H 85
L 45 P 45 H 85

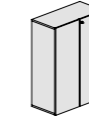

L 90 P 45 H 127
L 45 P 45 H 127



L 90 P 45 H 168
L 45 P 45 H 168

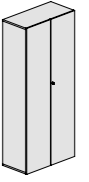

L 90 P 45 H 210
L 45 P 45 H 210

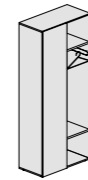

L 90 P 45 H 210
L 45 P 45 H 210



L 90 P 45 H 210
L 45 P 45 H 210

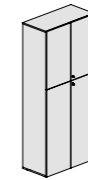

L 90 P 45 H 210
L 45 P 45 H 210



L 90 P 45 H 85
L 45 P 45 H 85

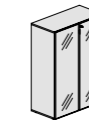

L 90 P 45 H 127
L 45 P 45 H 127



L 90 P 45 H 168
L 45 P 45 H 168

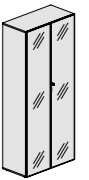

L 90 P 45 H 210
L 45 P 45 H 210



L 90 P 45 H 85
L 45 P 45 H 85

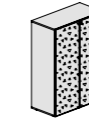

L 90 P 45 H 127
L 45 P 45 H 127

Mobilpref S.p.A. si riserva il diritto di apportare ai propri prodotti le modifiche ritenute utili o necessarie, senza pregiudicare le caratteristiche essenziali dei prodotti stessi. Foto e testi copyright Mobilpref S.p.A. Riproduzione senza autorizzazione non permessa.

Mobilpref S.p.A. reserves the right to apply changes to products deemed useful or necessary without compromising the essential product features. Photos and texts copyright Mobilpref S.p.A. Reproduction without authorization not allowed.

Mobilpref S.p.A. se réserve le droit d'apporter les modifications jugées utiles ou nécessaires à ses propres produits, sans compromettre les caractéristiques essentielles des produits eux-mêmes. Photos et textes Copyright Mobilpref S.p.A. La reproduction sans autorisation est interdite.





Mobilpref S.p.A.
Via Carlo Maccari, 10
Zona Industriale Baraccola Sud
60131 Ancona (AN) Italy
t. +39 071 290 6920 / f. +39 071 286 6429
info@about-office.it / www.about-office.it